

7005-16-L35-45

Steel, SAE J514 37° Flare DIN 2353 (Light) Tube Adapter Body Only, 1" Male JIC x M45X2.0 Male DIN

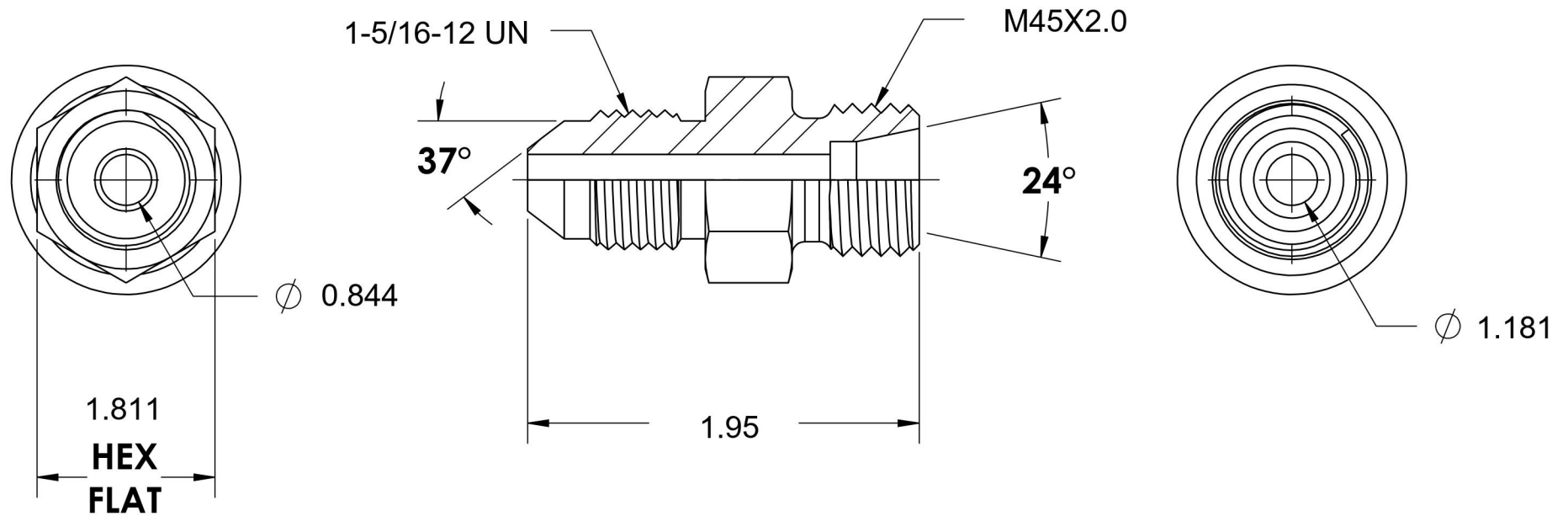

6701 Cochran Road
Solon, Ohio 44139
Phone: (440) 248-1880
Toll Free: 1-888-331-1523

Temperature Rating	Material	Industry Standards	Series
-65°F to 500°F	C1045 / 12L14 Steel	SAE J514, ISO 8434-1	7005-DIN LIGHT
Pressure Rating	Finish	DIN 2353, ASTM B633	Series Description
3600 psi	Trivalent Zinc		SAE J514 37° Flare DIN 2353 (Light) Tube Adapter Body Only