

6701-L-12-12

Steel, SAE J514 37° Flare 90° Long Swept Swivel Elbow, 3/4" Male JIC x 3/4" Female JIC Swivel

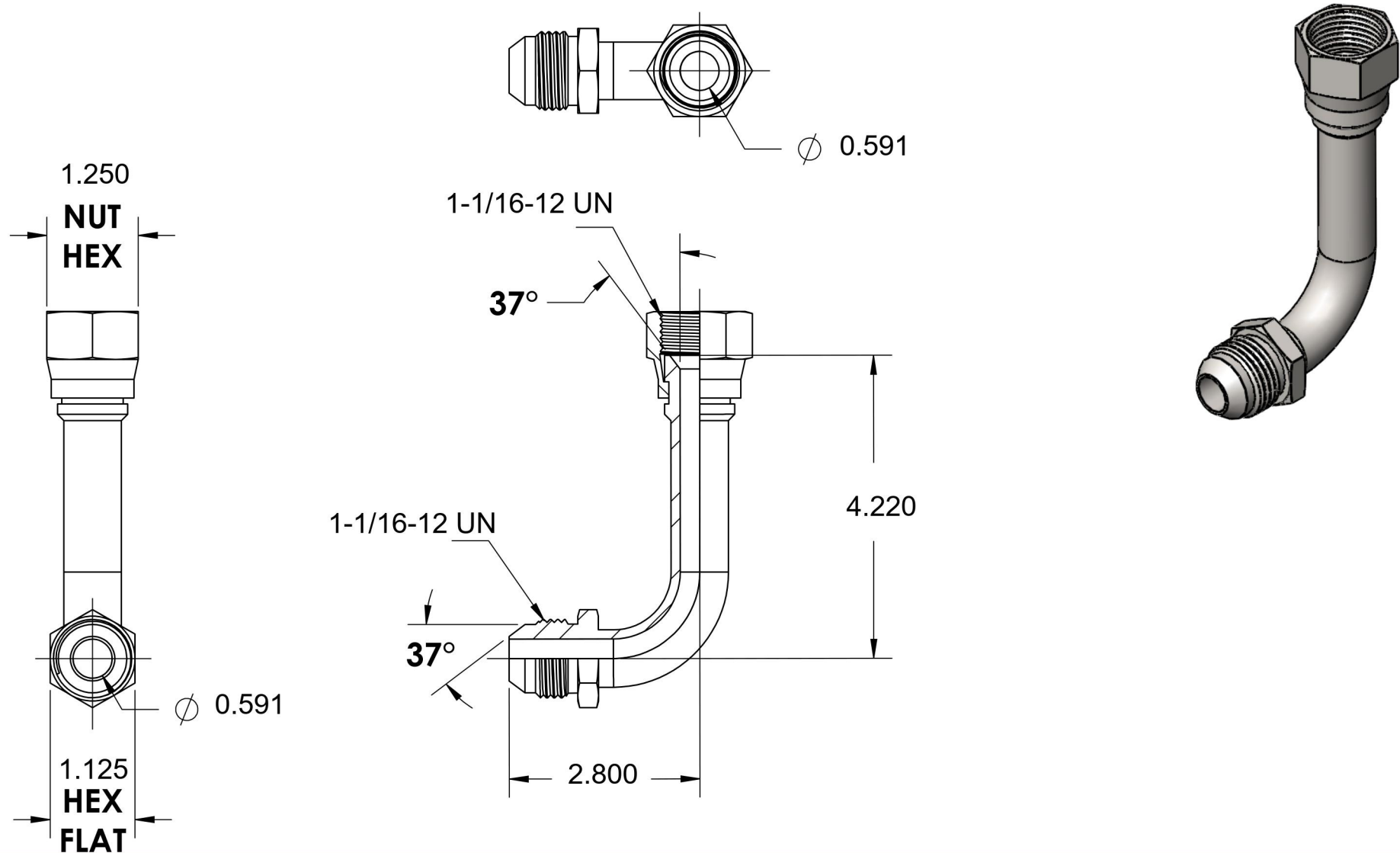

6701 Cochran Road
Solon, Ohio 44139
Phone: (440) 248-1880
Toll Free: 1-888-331-1523

Temperature Rating	Material	Industry Standards	Series
-65°F to 500°F	S20C Steel	SAE J514, ASTM B633	6701-L
Pressure Rating	Finish		Series Description
5000psi	Trivalent Zinc		SAE J514 37° Flare 90° Long Swept Swivel Elbow