

6801-08-16-NWO-FG

Steel, SAE J514 37° Flare 90° Adjustable Port Elbow, 1/2" Male JIC x 1-5/16-12 Male Adjustable ORB

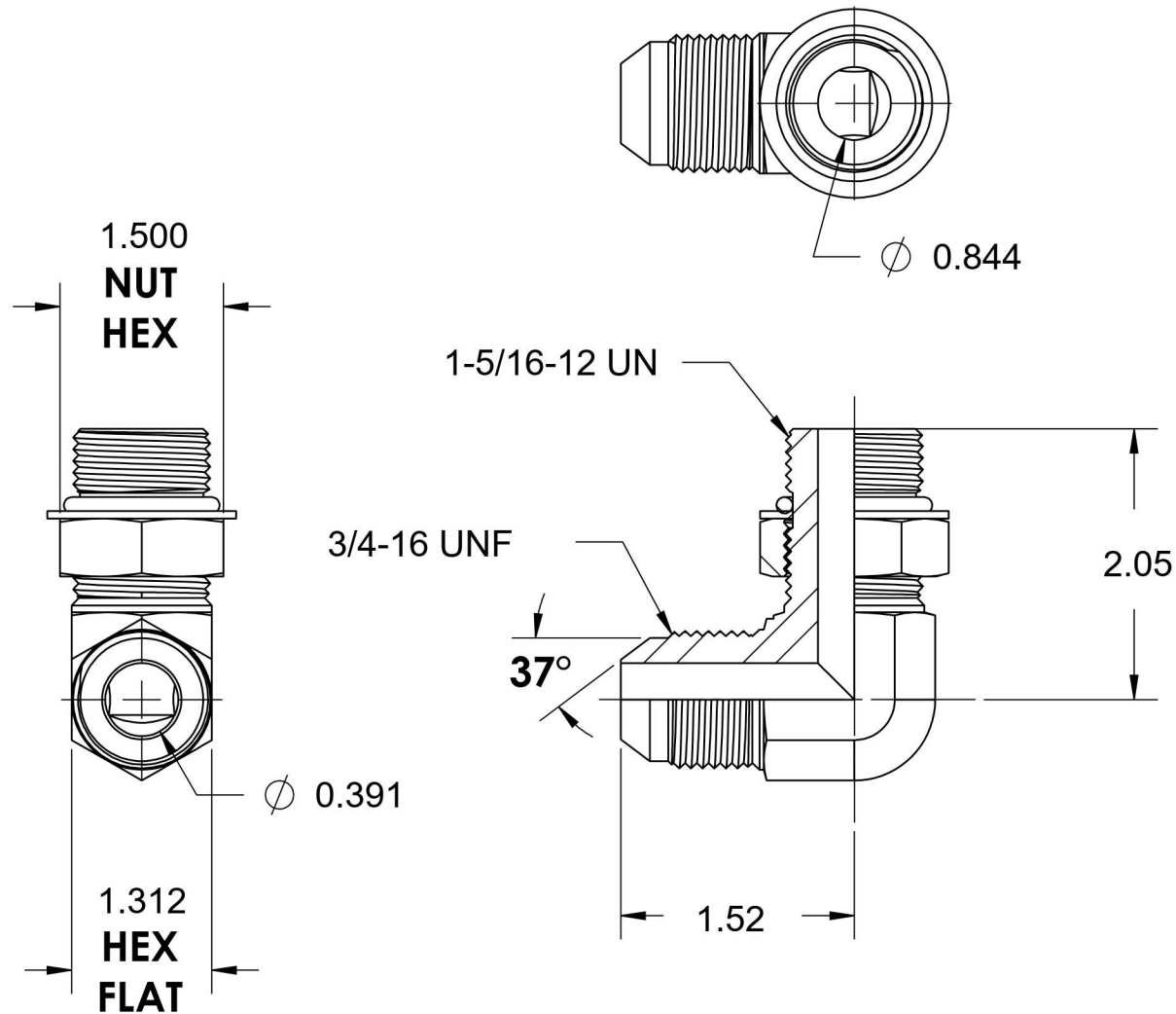

6701 Cochran Road
Solon, Ohio 44139
Phone: (440) 248-1880
Toll Free: 1-888-331-1523

Temperature Rating

-40°F / 250°F

Pressure Rating

4000 psi

Material

C1045 Steel

Finish

Trivalent Zinc

Industry Standards

SAE J514, SAE J1926-3

ASTM B633

Series

6801-NWO-FG

Series Description

SAE J514 37° Flare 90°
Adjustable Port Elbow