

6901-32-32-NWO-FG

Steel, SAE J514 NPSM Swivel 90° Adjustable Port Elbow, 2-1/2-12 Male Adjustable ORB x 2" Female NPSM Swivel

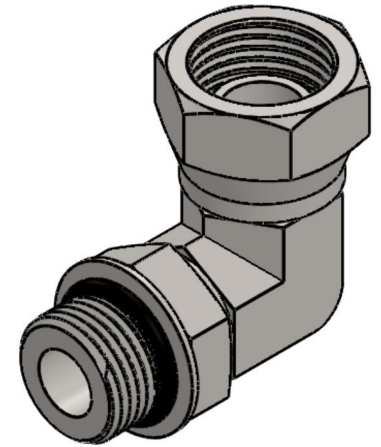
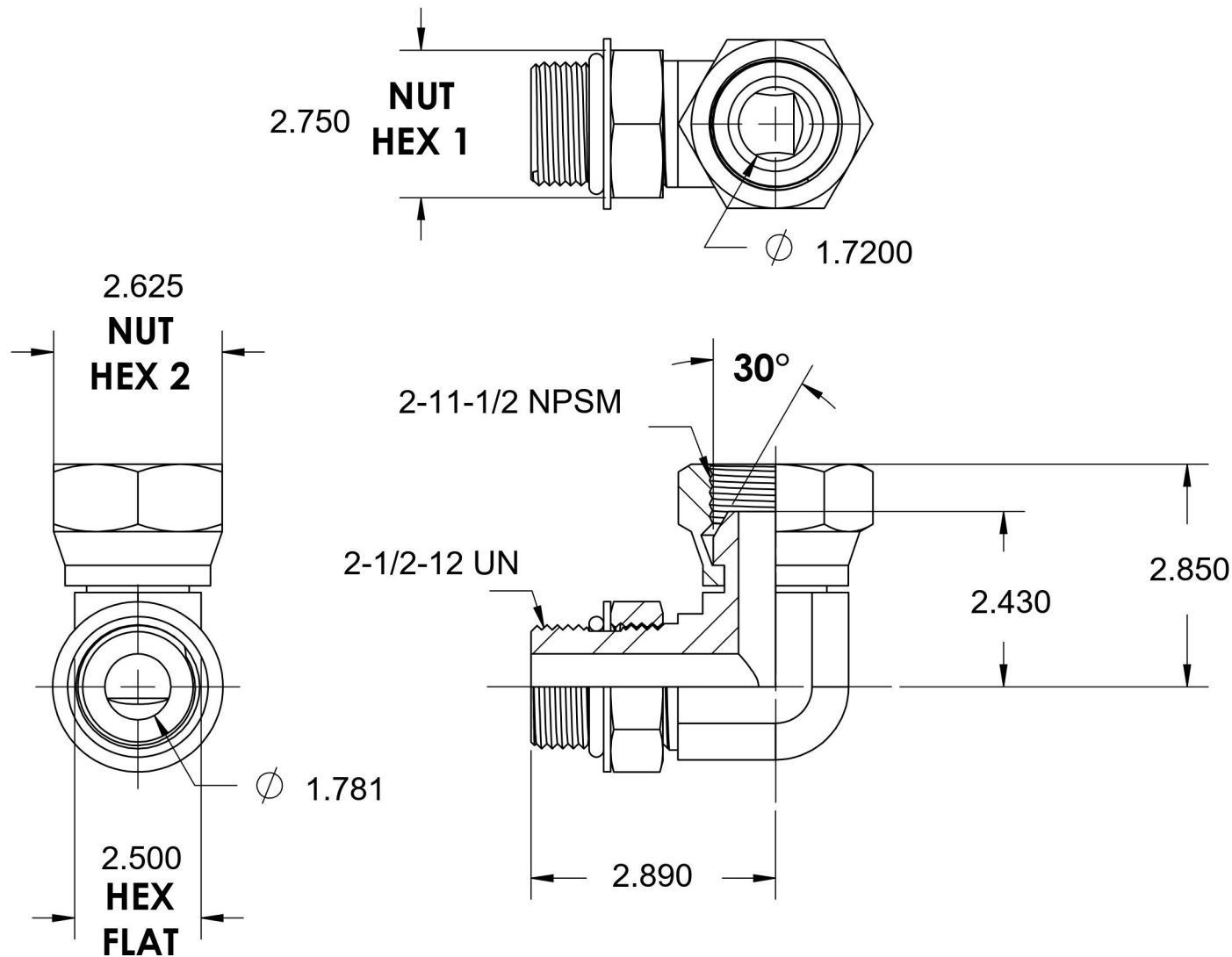

6701 Cochran Road
Solon, Ohio 44139
Phone: (440) 248-1880
Toll Free: 1-888-331-1523

Temperature Rating	Material	Industry Standards	Series
-40°F to 250°F	C1045 Steel	SAE J514, SAE J1926-3 SAE J515, ASTM B633	6901-NWO-FG
Pressure Rating	Finish		Series Description
1100 psi	Trivalent Zinc		SAE J514 NPSM Swivel 90° Adjustable Port Elbow