

# 5406-16-04

Steel, SAE J514 Pipe Reducer Bushing, 1" Male NPTF x 1/4" Female NPTF

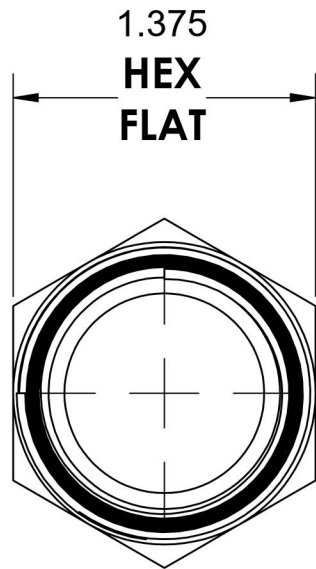

1-11-1/2 NPTF

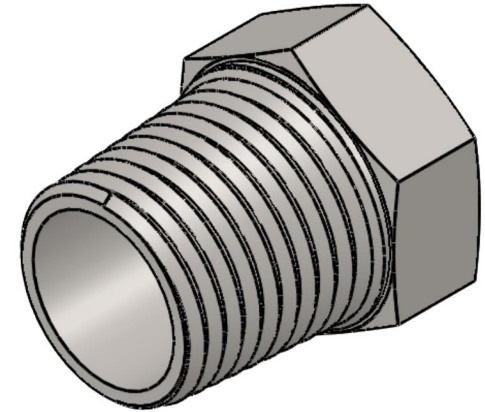
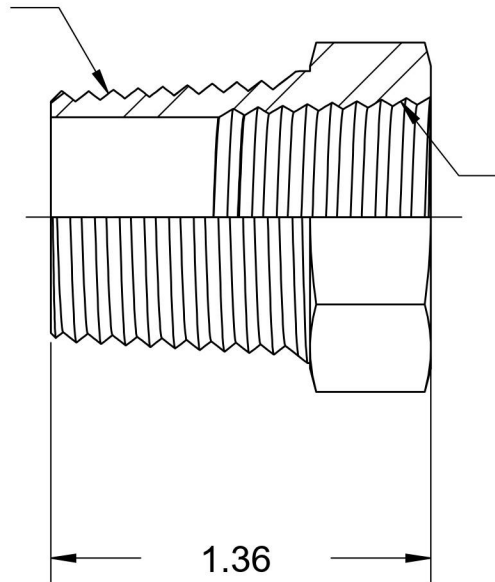

6701 Cochran Road  
Solon, Ohio 44139  
Phone: (440) 248-1880  
Toll Free: 1-888-331-1523

**Temperature Rating**

-65°F to 500°F

**Pressure Rating**

4500 psi

**Material**

C1045/12L14 Steel

**Finish**

Trivalent Zinc

**Industry Standards**

SAE J514 , SAE J476  
ASTM B633

**Series**

5406

**Series Description**

SAE J514 Pipe Reducer Bushing