

6801-05-04-NWO-FG

Steel, SAE J514 37° Flare 90° Adjustable Port Elbow, 5/16" Male JIC x 7/16-20 Male Adjustable ORB

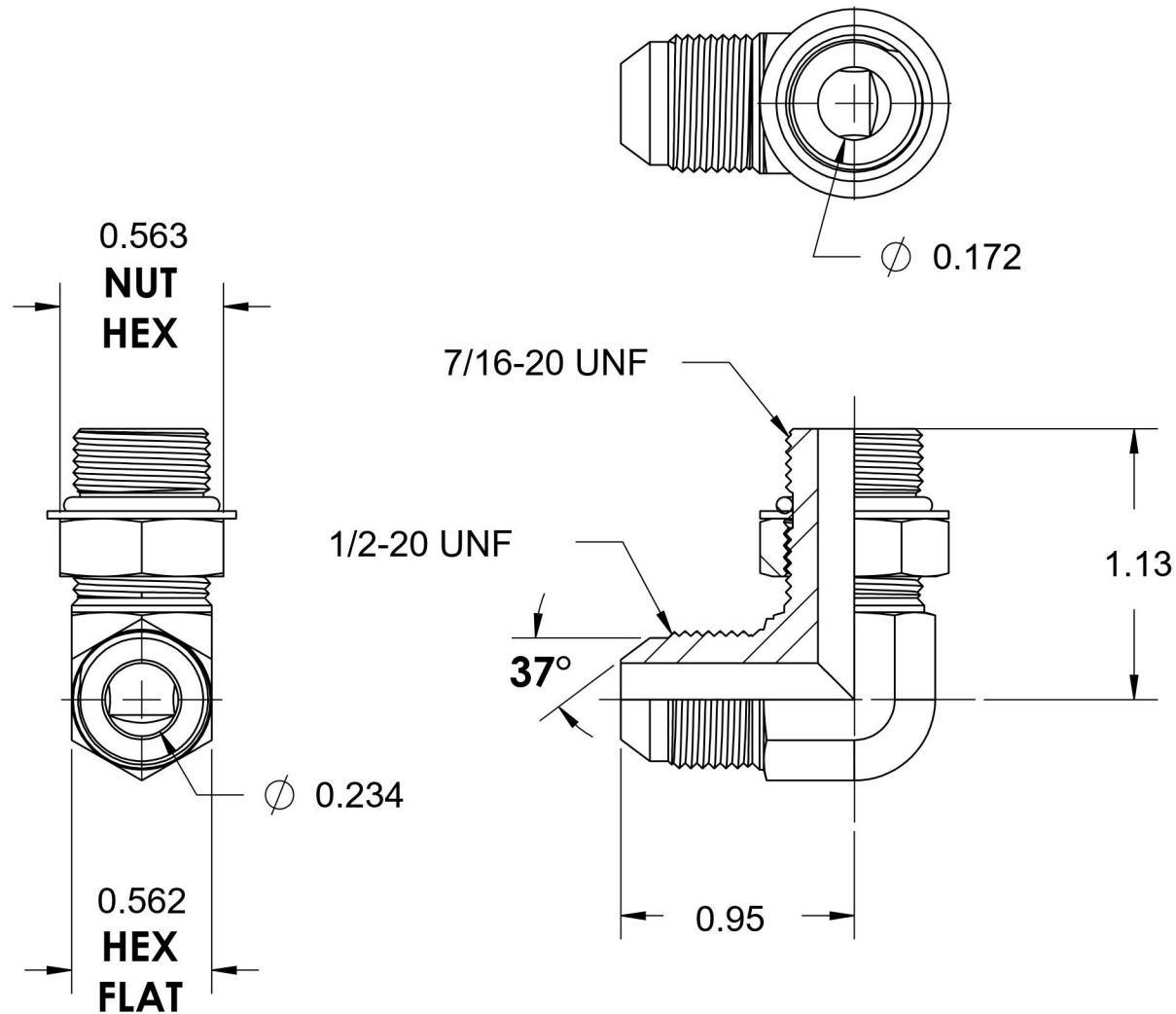

6701 Cochran Road
Solon, Ohio 44139
Phone: (440) 248-1880
Toll Free: 1-888-331-1523

Temperature Rating -40°F / 250°F	Material C1045 Steel	Industry Standards SAE J514, SAE J1926-3 ASTM B633	Series 6801-NWO-FG
Pressure Rating 6000 psi	Finish Trivalent Zinc		Series Description SAE J514 37° Flare 90° Adjustable Port Elbow