

5600-02-02-02-FG

Steel, SAE J514 Pipe Male Tee, 1/8" Male NPTF 30°

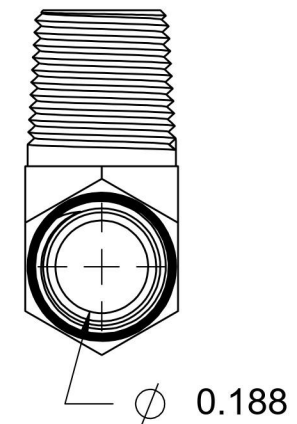
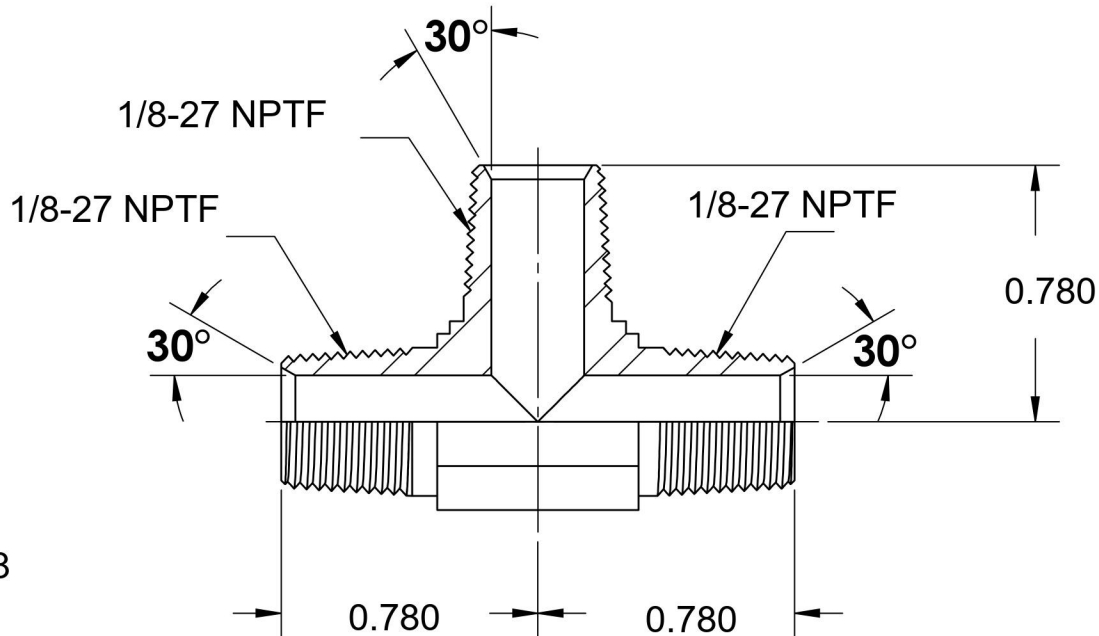
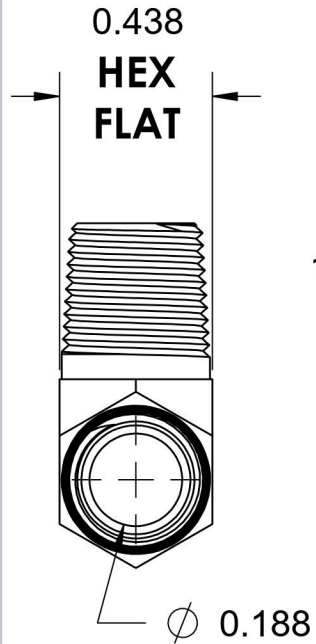
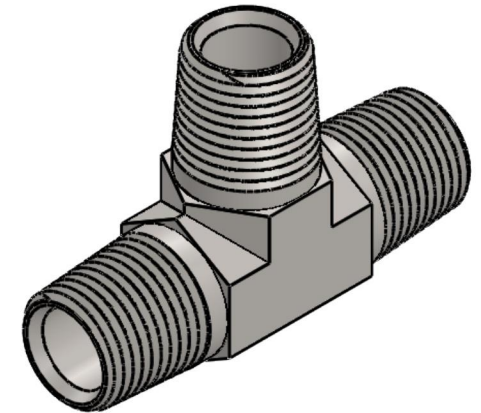
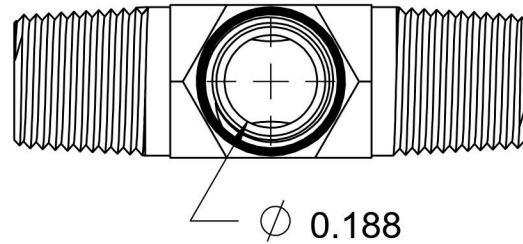

6701 Cochran Road
Solon, Ohio 44139
Phone: (440) 248-1880
Toll Free: 1-888-331-1523

Temperature Rating

-65°F to 500°F

Pressure Rating

6000psi

Material

C1045 Steel

Finish

Trivalent Zinc

Industry Standards

SAE J514 , SAE J476
ASTM B633

Series

5600-FG

Series Description

SAE J514 Pipe Male Tee