

FS6564-12-12-04

Steel, SAE J1453 O-Ring Face Seal Swivel Adapter ORB Diagnostic Port, 3/4" Male ORFS x 3/4" Female ORFS Swivel

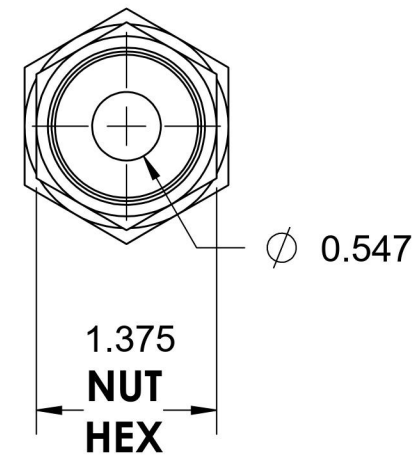
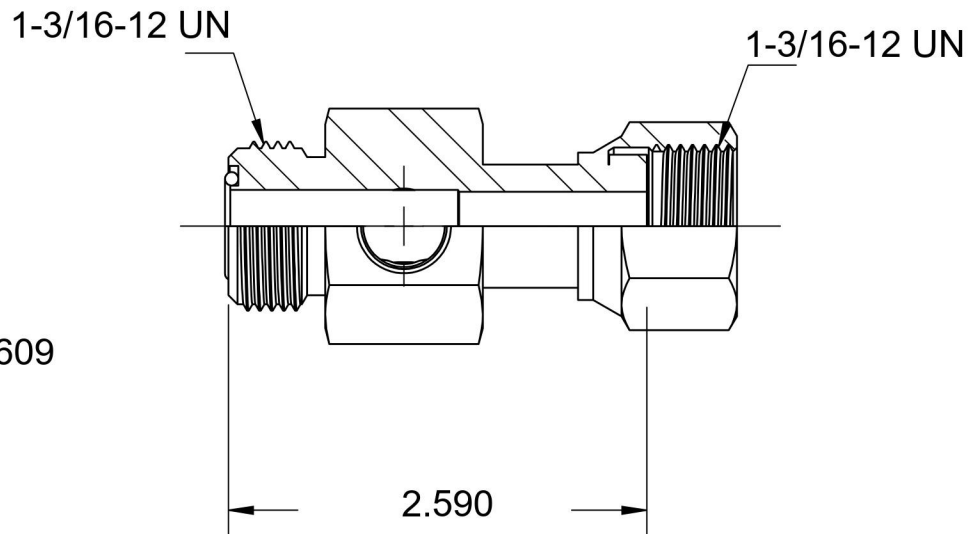
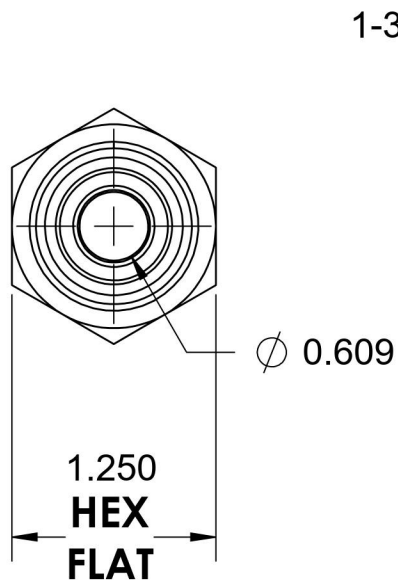
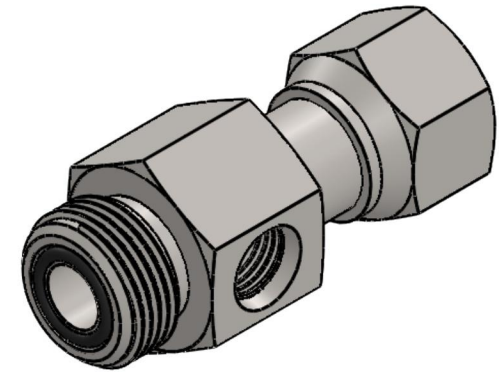
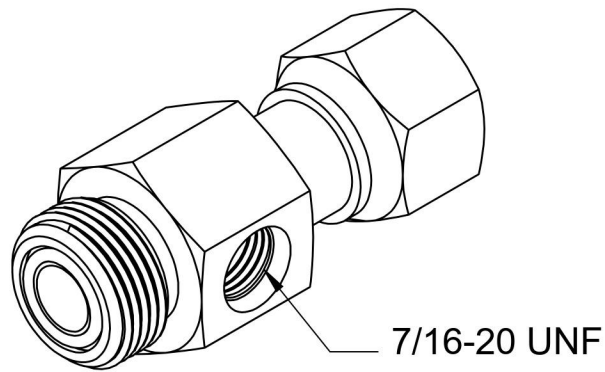

6701 Cochran Road
Solon, Ohio 44139
Phone: (440) 248-1880
Toll Free: 1-888-331-1523

Temperature Rating

-40°F to 250°F

Pressure Rating

6000 psi

Material

C1045/12L14 Steel

Finish

Trivalent Zinc

Industry Standards

SAE J1453, SAE J1926-1
ASTM B633

Series

FS6564

Series Description

SAE J1453 O-Ring Face Seal Swivel Adapter
ORB Diagnostic Port