

6901-06-04-NWO-FG

Steel, SAE J514 NPSM Swivel 90° Adjustable Port Elbow, 9/16-18 Male Adjustable ORB x 1/4" Female NPSM Swivel

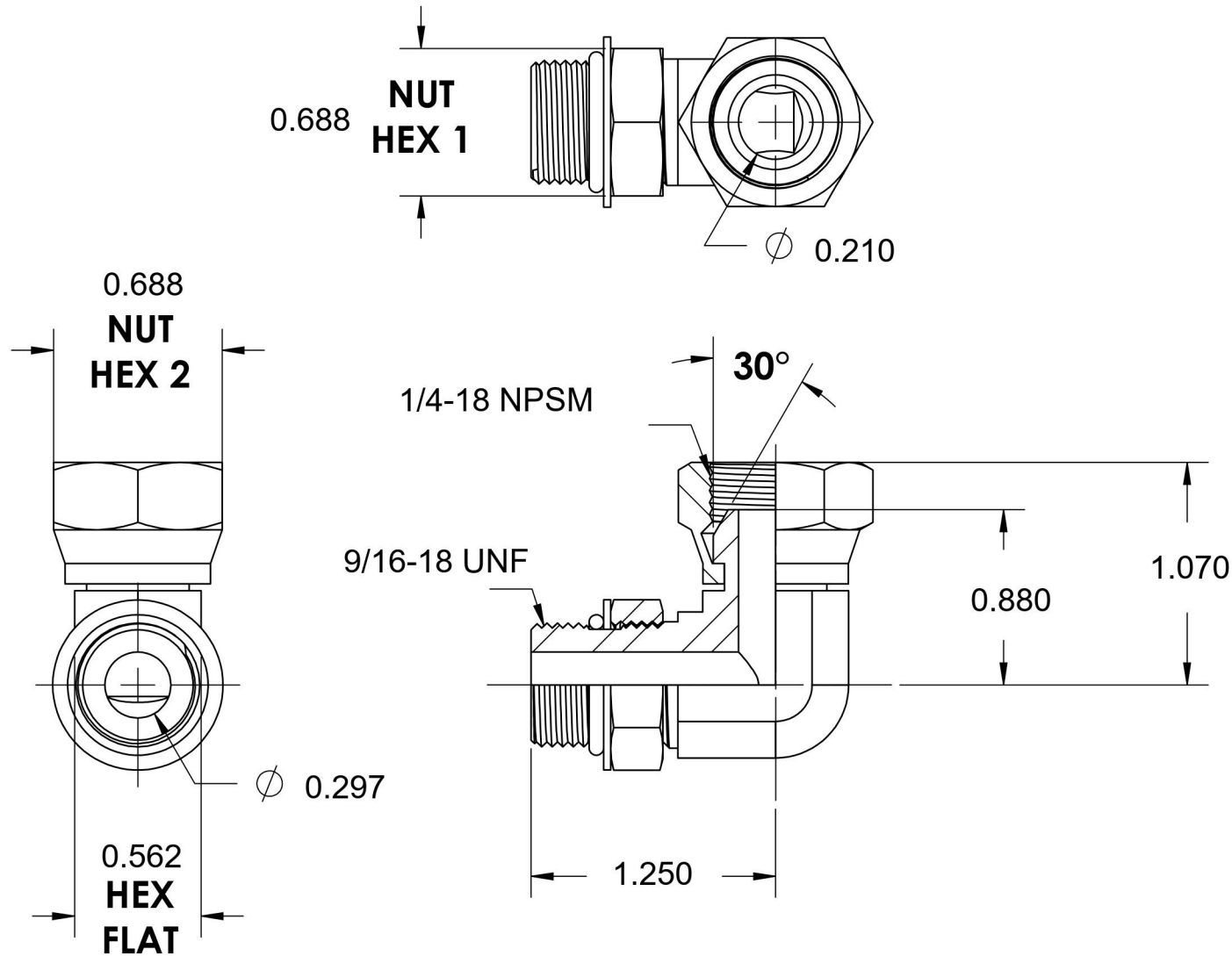

6701 Cochran Road
Solon, Ohio 44139
Phone: (440) 248-1880
Toll Free: 1-888-331-1523

Temperature Rating

-40°F to 250°F

Pressure Rating

6000 psi

Material

C1045 Steel

Finish

Trivalent Zinc

Industry Standards

SAE J514, SAE J1926-3
SAE J515, ASTM B633

Series

6901-NWO-FG

Series Description

SAE J514 NPSM Swivel 90° Adjustable Port Elbow