

7202-08-04-NWO-FG

Steel, SAE J514 37° Flare Male BSPP Adjustable (Type H) Port 90° Elbow, 1/2" Male JIC x 1/4-19 Male BSPP Adjustable ORR

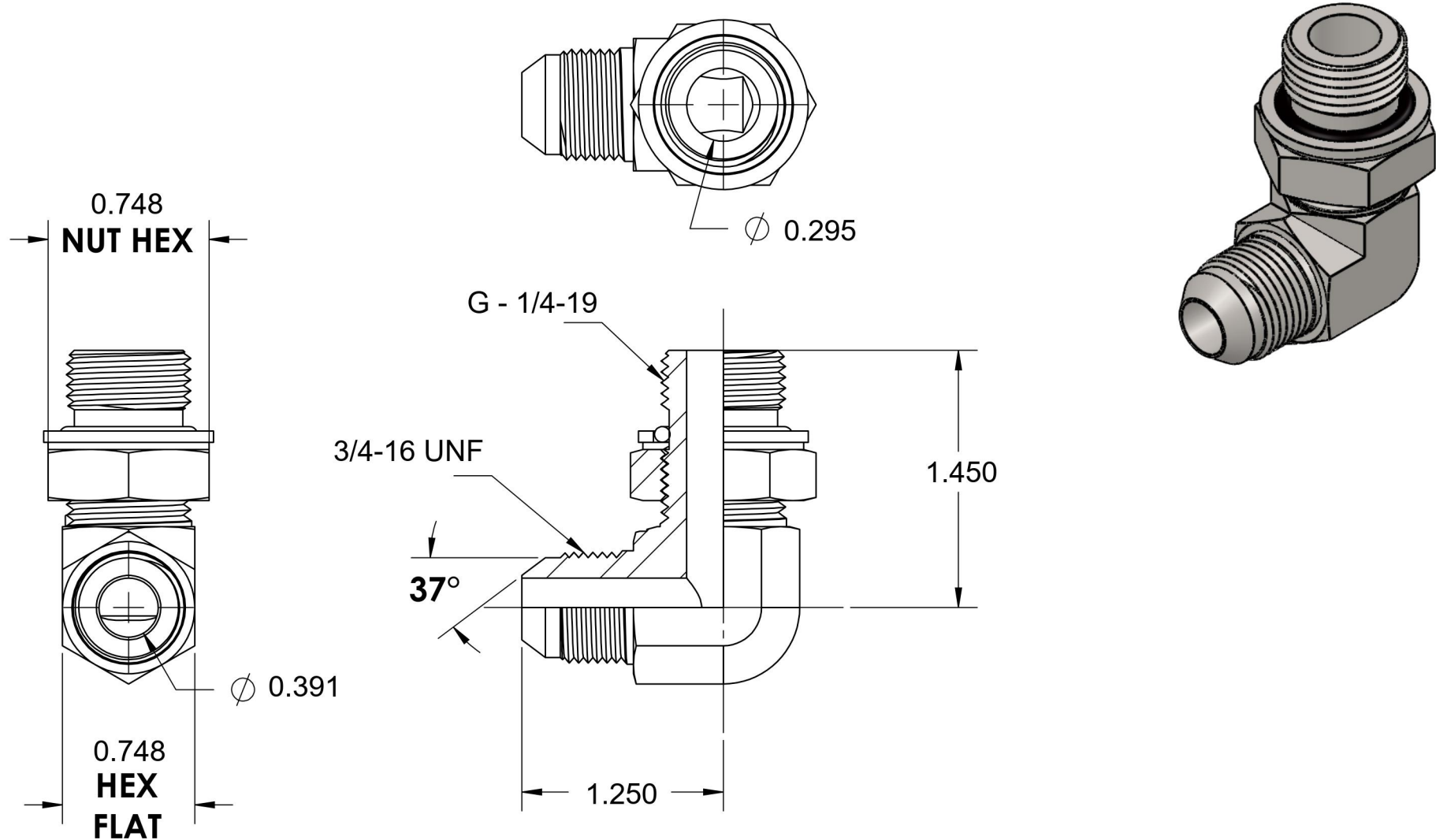

6701 Cochran Road
Solon, Ohio 44139
Phone: (440) 248-1880
Toll Free: 1-888-331-1523

Temperature Rating

-40°F to 250°F

Pressure Rating

3600 psi

Material

C1045 Steel

Finish

Trivalent Zinc

Industry Standards

SAE J514, ISO 1179
ASTM B633

Series

7202-NWO-FG-ORR

Series Description

SAE J514 37° Flare Male BSPP Adjustable (Type H) Port 90° Elbow