

2406-14-04

Steel, SAE J514 37° Flare Reducer, 7/8" Female JIC x 1/4" Male JIC

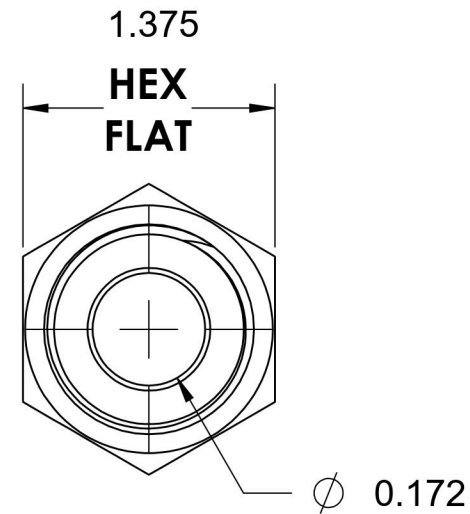
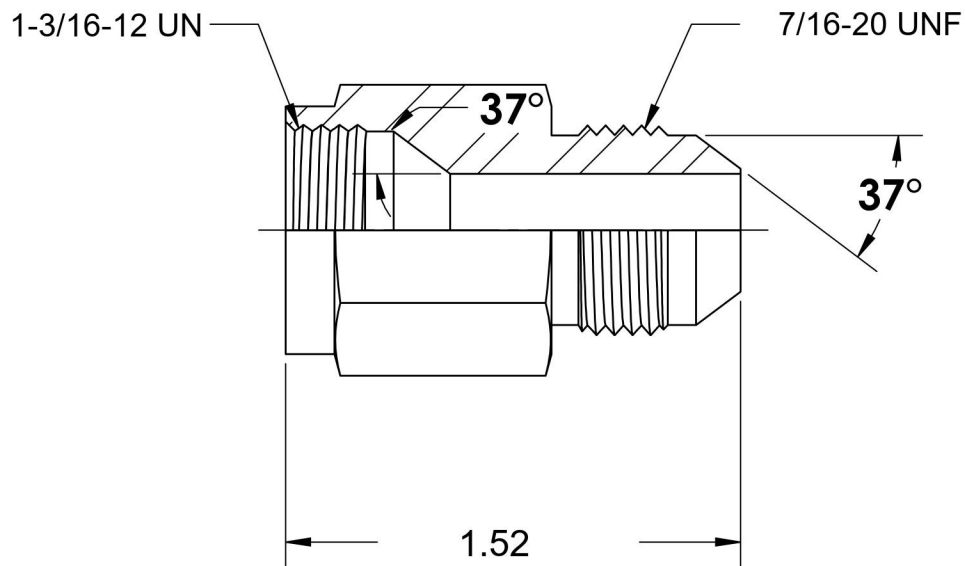

6701 Cochran Road
Solon, Ohio 44139
Phone: (440) 248-1880
Toll Free: 1-888-331-1523

| | | | |
|---|--------------------------------------|--|---|
| Temperature Rating -65°F to 500°F | Material C1045/12L14 Steel | Industry Standards SAE J514, ASTM B633 | Series 2406 |
| Pressure Rating 5000 psi | Finish Trivalent Zinc | | Series Description SAE J514 37° Flare Reducer |