

# 6802-12-10-NWO-FG

Steel, SAE J514 37° Flare 45° Adjustable Port Elbow, 3/4" Male JIC x 7/8-14 Male Adjustable ORB

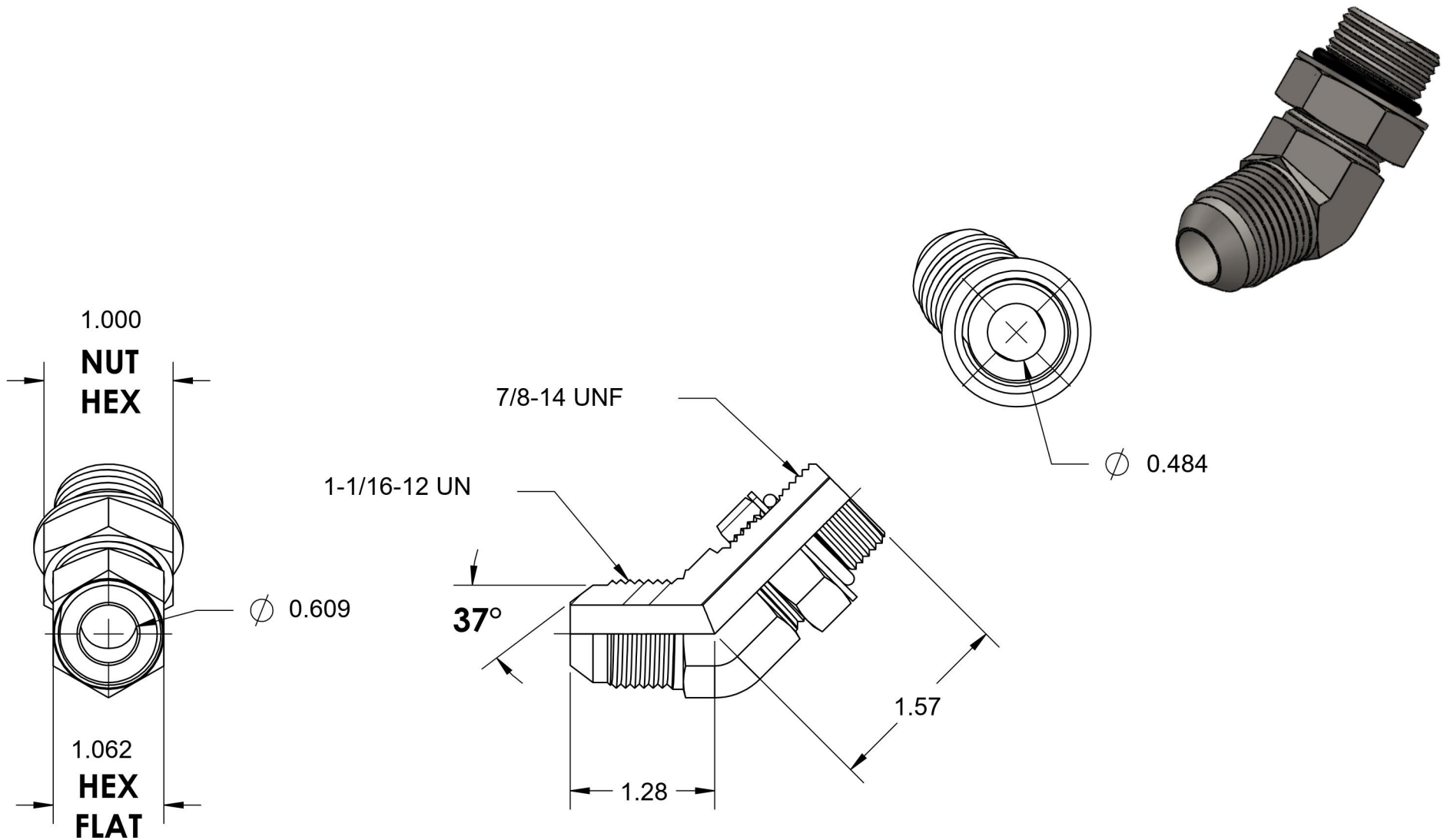

6701 Cochran Road  
Solon, Ohio 44139  
Phone: (440) 248-1880  
Toll Free: 1-888-331-1523

<b>Temperature Rating</b>	<b>Material</b>	<b>Industry Standards</b>	<b>Series</b>
-40°F to 250°F	C1045 Steel	SAE J514, SAE J1926-3	6802-NWO-FG
<b>Pressure Rating</b>	<b>Finish</b>	SAE J515, ASTM B633	<b>Series Description</b>
5000 psi	Trivalent Zinc		SAE J514 37° Flare 45° Adjustable Port Elbow