

6801-24-24-NWO-SS

Stainless Steel, SAE J514 37° Flare 90° Adjustable Port Elbow, 1-1/2" Male JIC x 1-7/8-12 Male Adjustable ORB

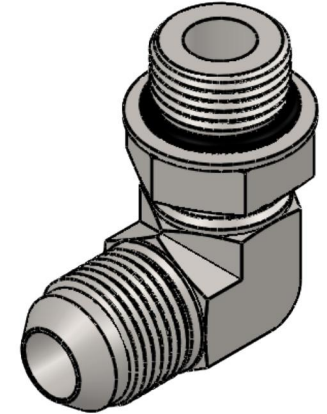
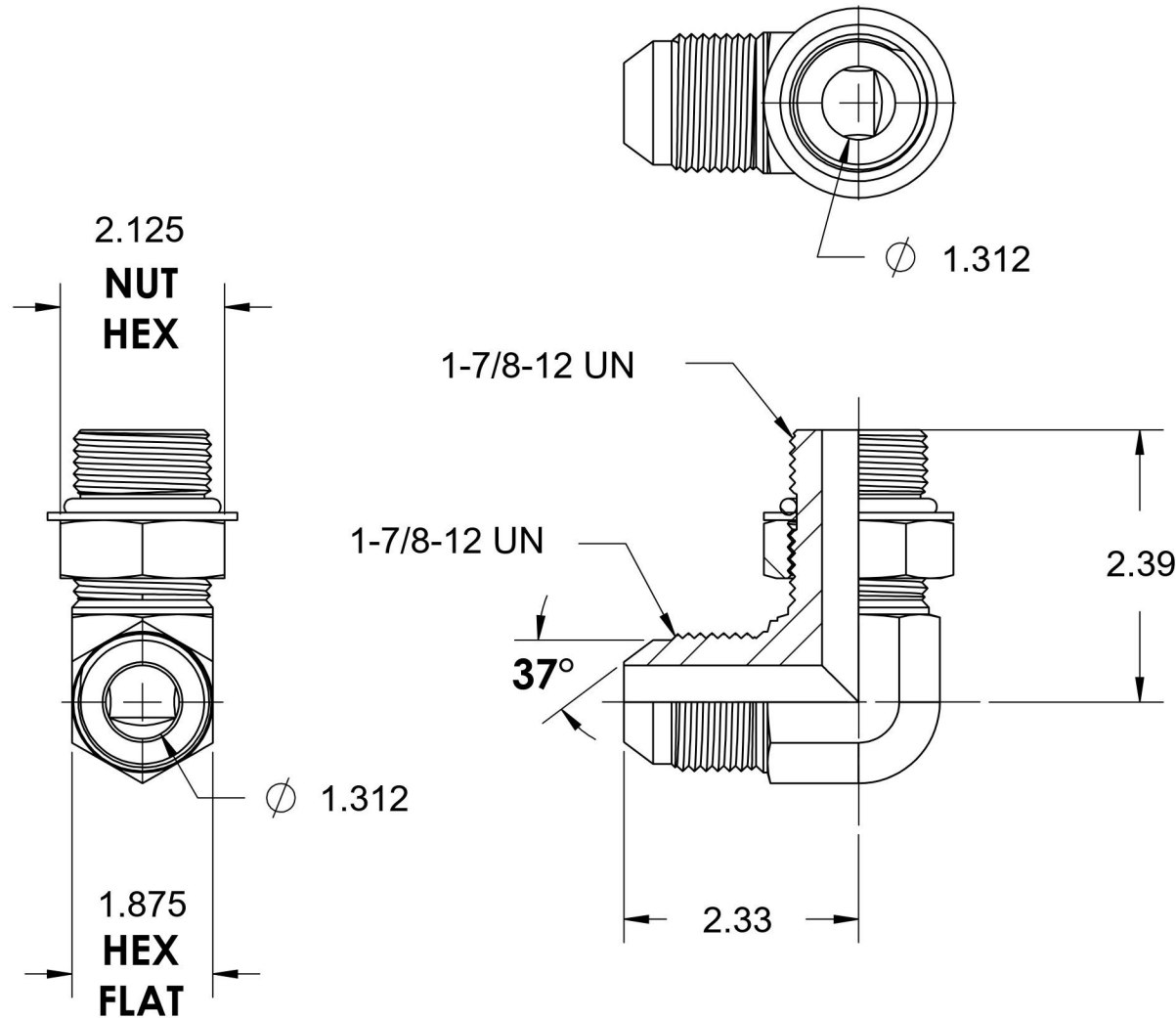

6701 Cochran Road
Solon, Ohio 44139
Phone: (440) 248-1880
Toll Free: 1-888-331-1523

Temperature Rating	Material	Industry Standards	Series
-40°F / 250°F	316/316L Stainless Steel	SAE J514, SAE J1926-3	6801-NWO-SS
Pressure Rating	Finish		Series Description
2000 psi	Passivated		SAE J514 37° Flare 90° Adjustable Port Elbow