

7005-10-L18-26-NBR

Steel, SAE J514 37° Flare/ISO 8434-1 Light Series Male Adapter, Nut and Bite Ring Assembled, 5/8" Male JIC x M26X1.5 DIN Tube

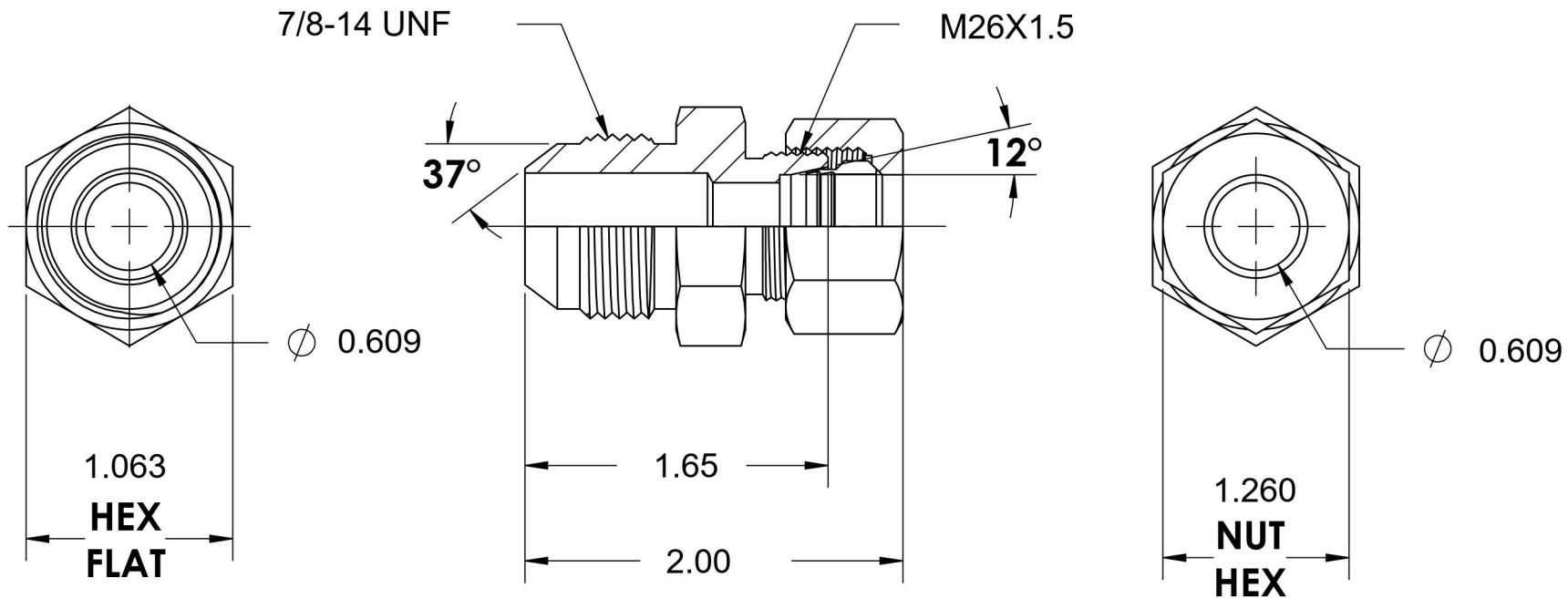

6701 Cochran Road
Solon, Ohio 44139
Phone: (440) 248-1880
Toll Free: 1-888-331-1523

Temperature Rating	Material	Industry Standards	Series
-65°F to 500°F	C1045 / 12L14 Steel	SAE J514, ISO 8434-1	7005-DIN LIGHT-NBR
Pressure Rating	Finish	ASTM B633	Series Description
5000 psi	Trivalent Zinc		SAE J514 37° Flare/ISO 8434-1 Light Series Male Adapter Nut and Bite Ring Assembled