

FS2404-12-12-VITON

Steel, SAE J1453 O-Ring Face Seal Male Connector, 3/4" Male ORFS x 3/4" Male NPTF 30°, FKM Seal

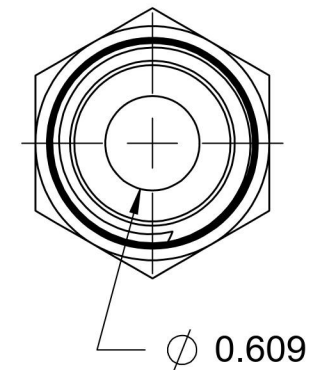
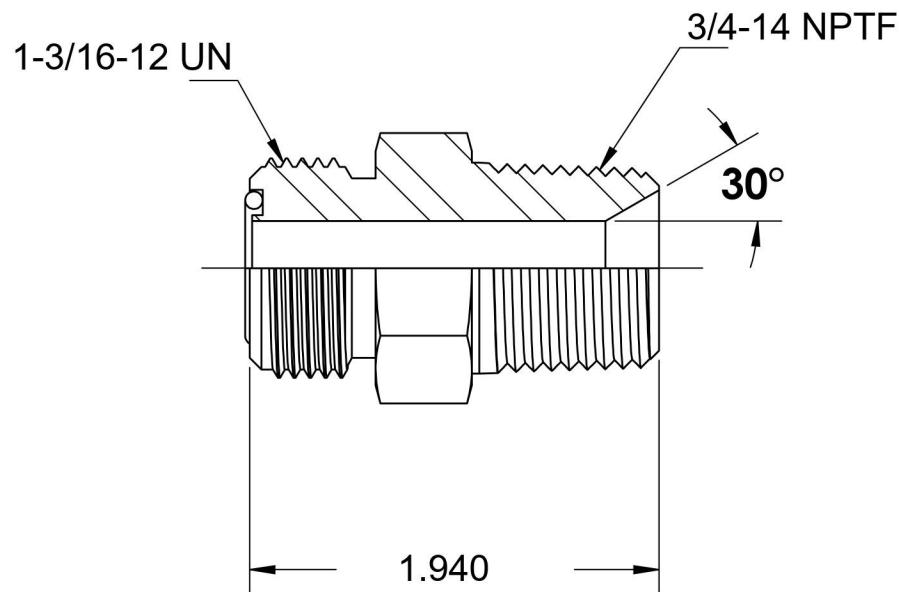
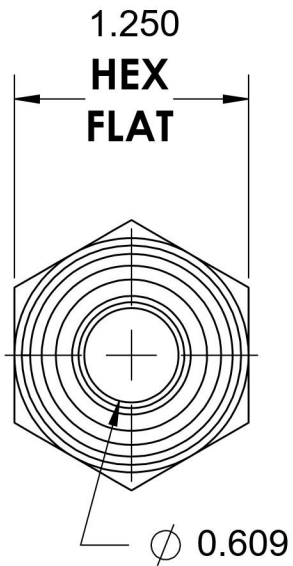
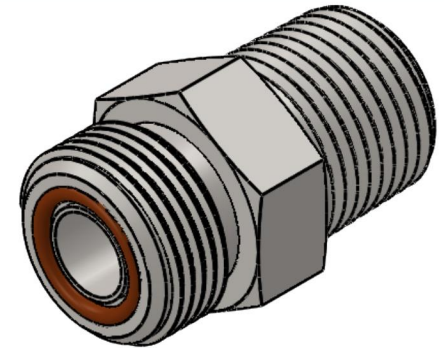

6701 Cochran Road
Solon, Ohio 44139
Phone: (440) 248-1880
Toll Free: 1-888-331-1523

Temperature Rating

-15°F to 400°F

Pressure Rating

5500 psi

Material

C1045 / 12L14 Steel

Finish

Trivalent Zinc

Industry Standards

SAE J1453, SAE J476
SAE J515, ASTM B633

Series

FS2404-VITON

Series Description

SAE J1453 O-Ring Face Seal
Male Connector