

1704-08-12-SS

Stainless Steel, SAE J514 37° Flare 90° Code 61 Flange Swept Elbow, 1/2" Male JIC x 3/4" Split Flange Head

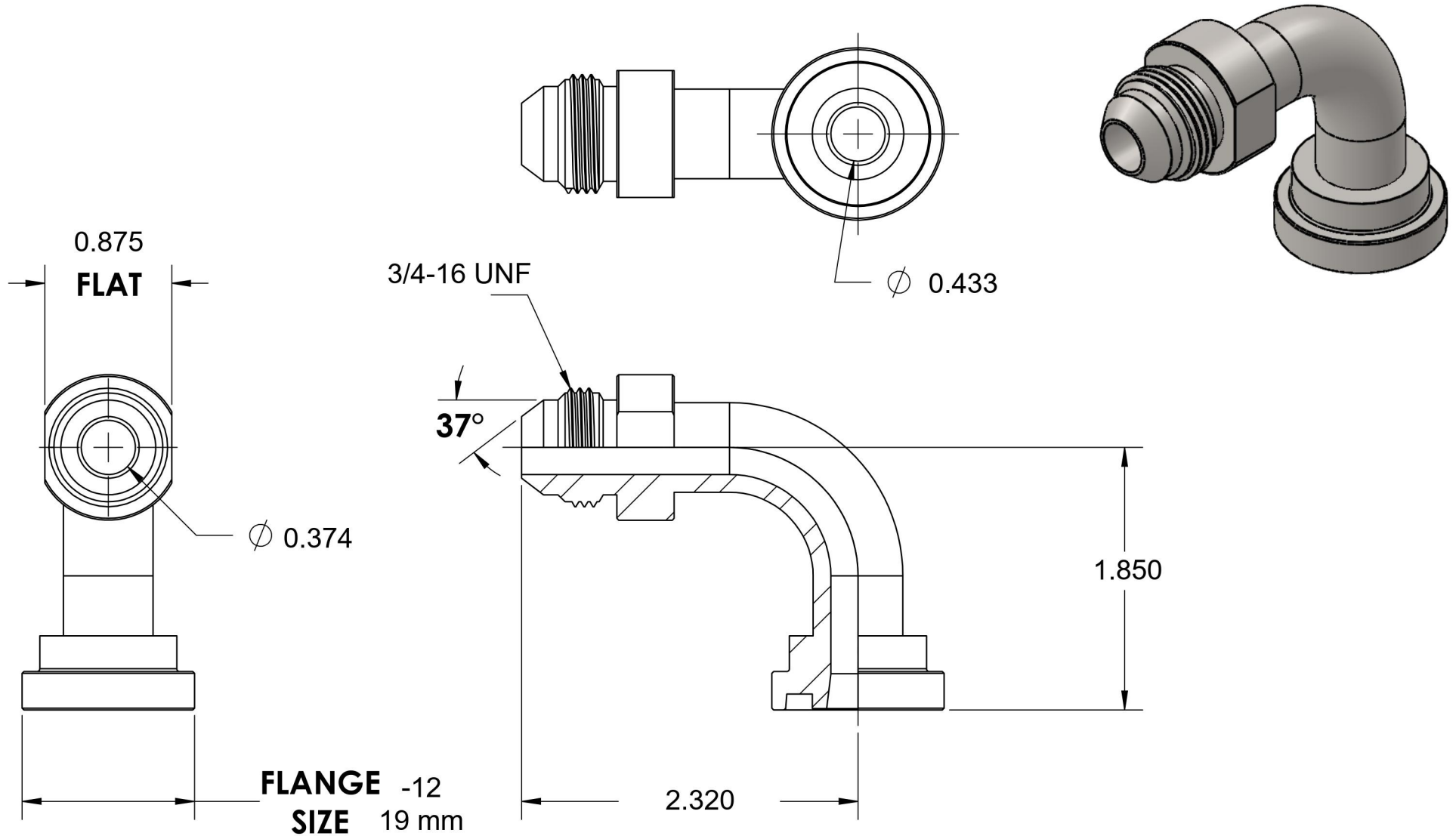

6701 Cochran Road
Solon, Ohio 44139
Phone: (440) 248-1880
Toll Free: 1-888-331-1523

Temperature Rating	Material	Industry Standards	Series
-425°F to 1200°F	316/316L Stainless Steel	SAE J518 Code 61, SAE J514	1704-SS
Pressure Rating	Finish		Series Description
5000 psi	Passivation		SAE J514 37° Flare 90° Code 61 Flange Swept Elbow