

7001-08-22-SS

Stainless Steel, SAE J514 37° Flare Male Metric Type (G) Port Adapter, 1/2" Male JIC x M22X1.5 Male Metric ORR

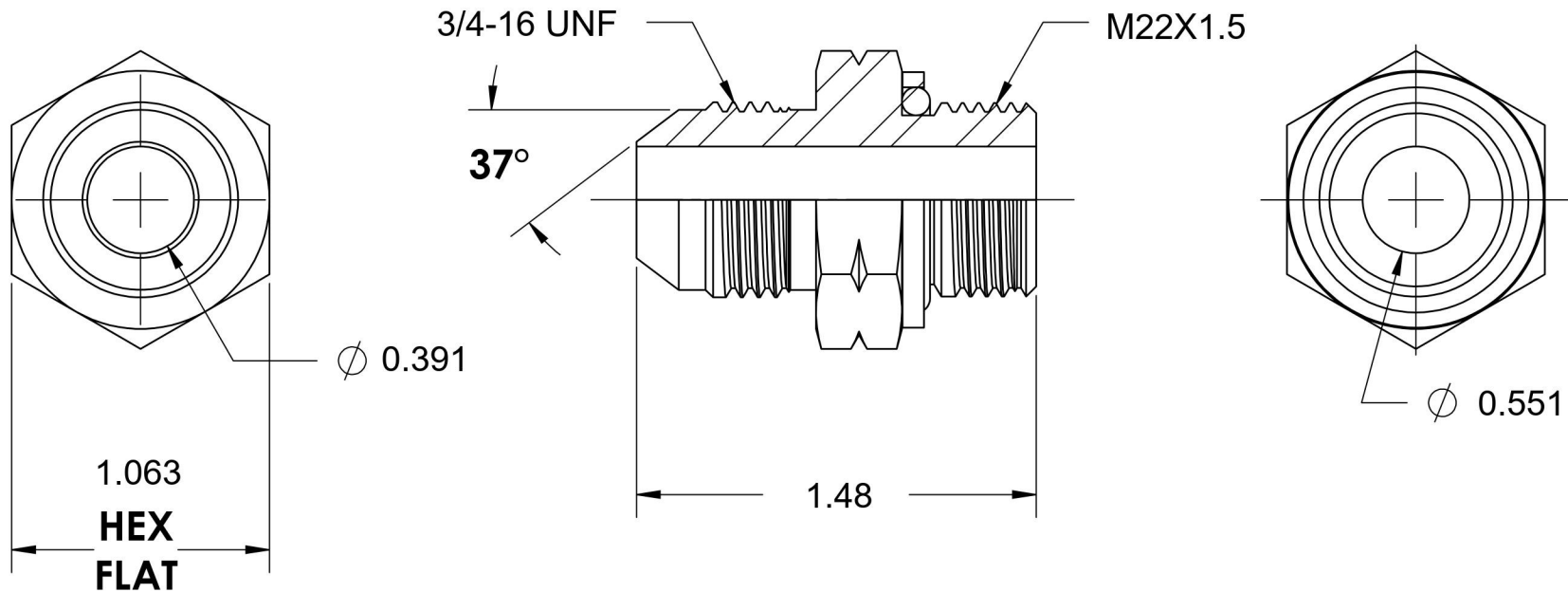

6701 Cochran Road
Solon, Ohio 44139
Phone: (440) 248-1880
Toll Free: 1-888-331-1523

Temperature Rating

-22°F to 257°F

Pressure Rating

3600 psi

Material

316/316L Stainless Steel

Finish

Passivated

Industry Standards

SAE J514, ISO 9974

Series

7001-ORR-SS

Series Description

SAE J514 37° Flare Male Metric Type (G) Port Adapter