

FS6804-08-12-08-NWO-FG

Steel, SAE J1453 O-Ring Face Seal Adjustable Port Run Tee, 1/2" Male ORFS x 1-1/16-12 Male Adjustable ORB x 1/2" Male ORFS

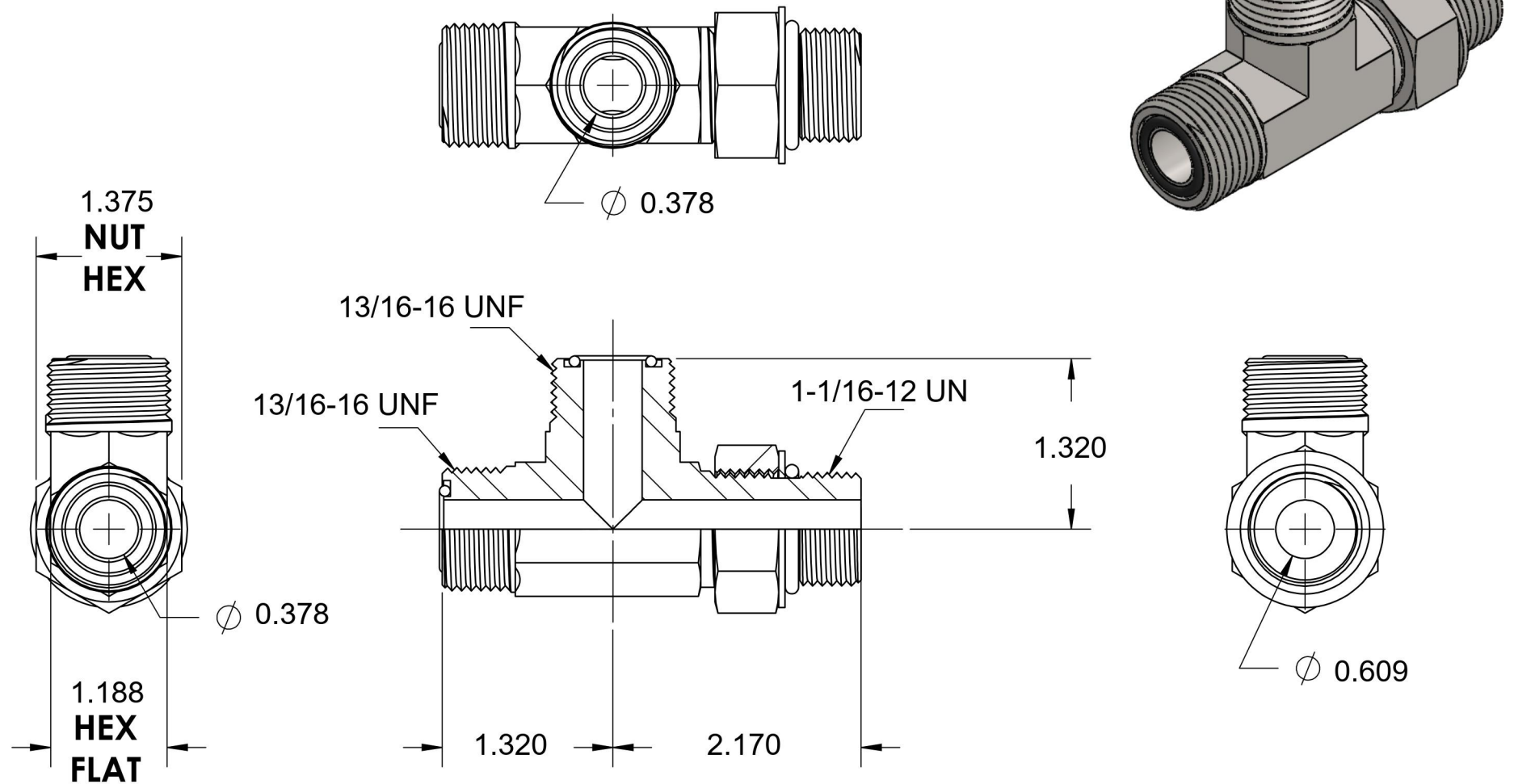

6701 Cochran Road
Solon, Ohio 44139
Phone: (440) 248-1880
Toll Free: 1-888-331-1523

Temperature Rating

-40°F to 250°F

Pressure Rating

6000 psi

Material

C1045 Steel

Finish

Trivalent Zinc

Industry Standards

SAE J1453, SAE J1926-2
SAE J515, ASTM B633

Series

FS6804-NWO-FG

Series Description

SAE J1453 O-Ring Face Seal
Adjustable Port Run Tee