

1503-06-06-SS

Stainless Steel, SAE J514 NPSM Swivel 45° Male Elbow, 3/8" Male NPTF 30° x 3/8" Female NPSM Swivel

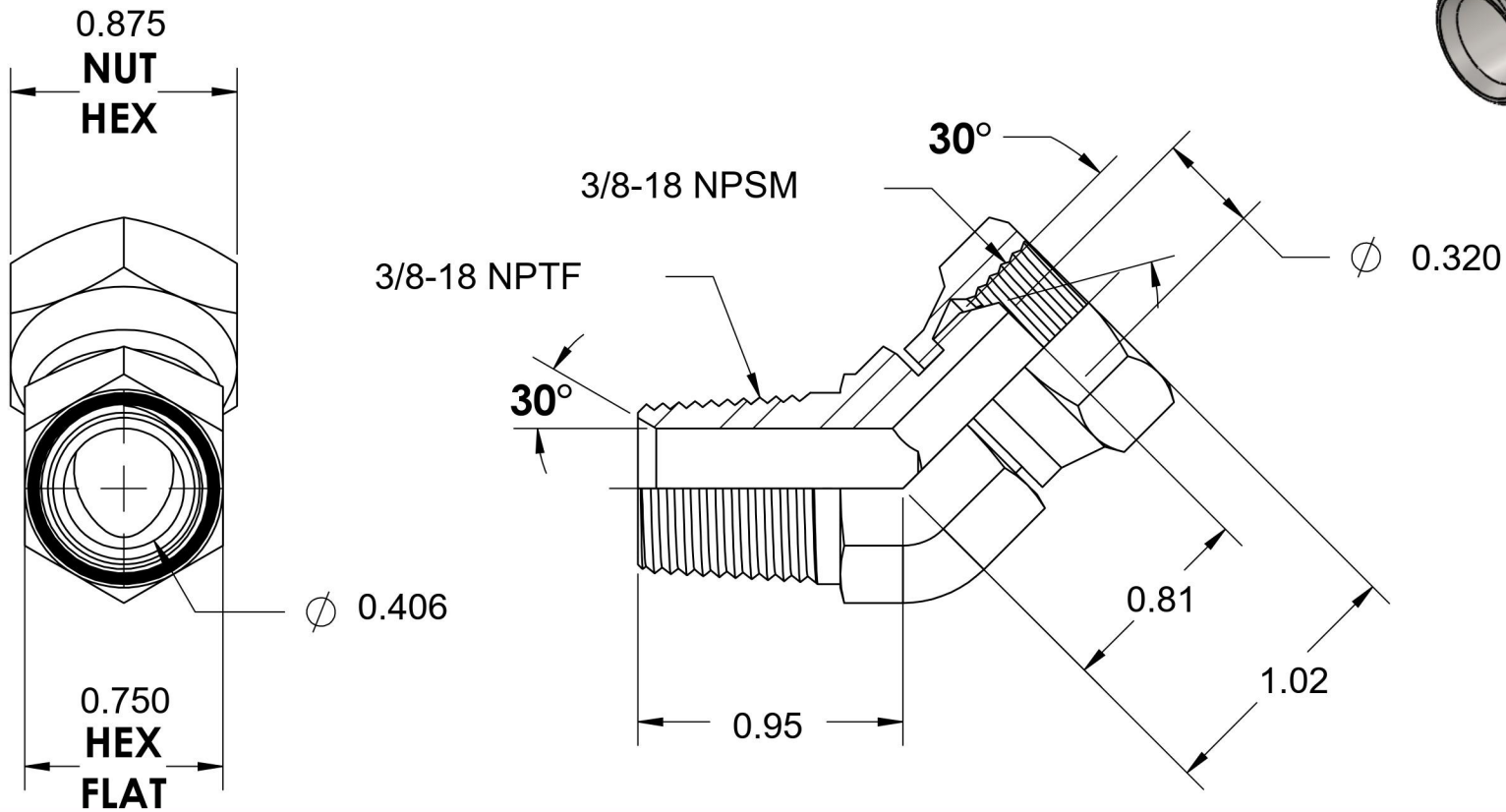

6701 Cochran Road
Solon, Ohio 44139
Phone: (440) 248-1880
Toll Free: 1-888-331-1523

Temperature Rating	Material	Industry Standards	Series
-425°F to 1200°F	316/316L Stainless Steel		
Pressure Rating	Finish	Series Description	
6000 psi	Passivated	SAE J514 NPSM Swivel 45° Male Elbow	