

6500-06-06-SS

Stainless Steel, SAE J514 37° Flare 90° Swivel Elbow, 3/8" Male JIC x 3/8" Female JIC Swivel

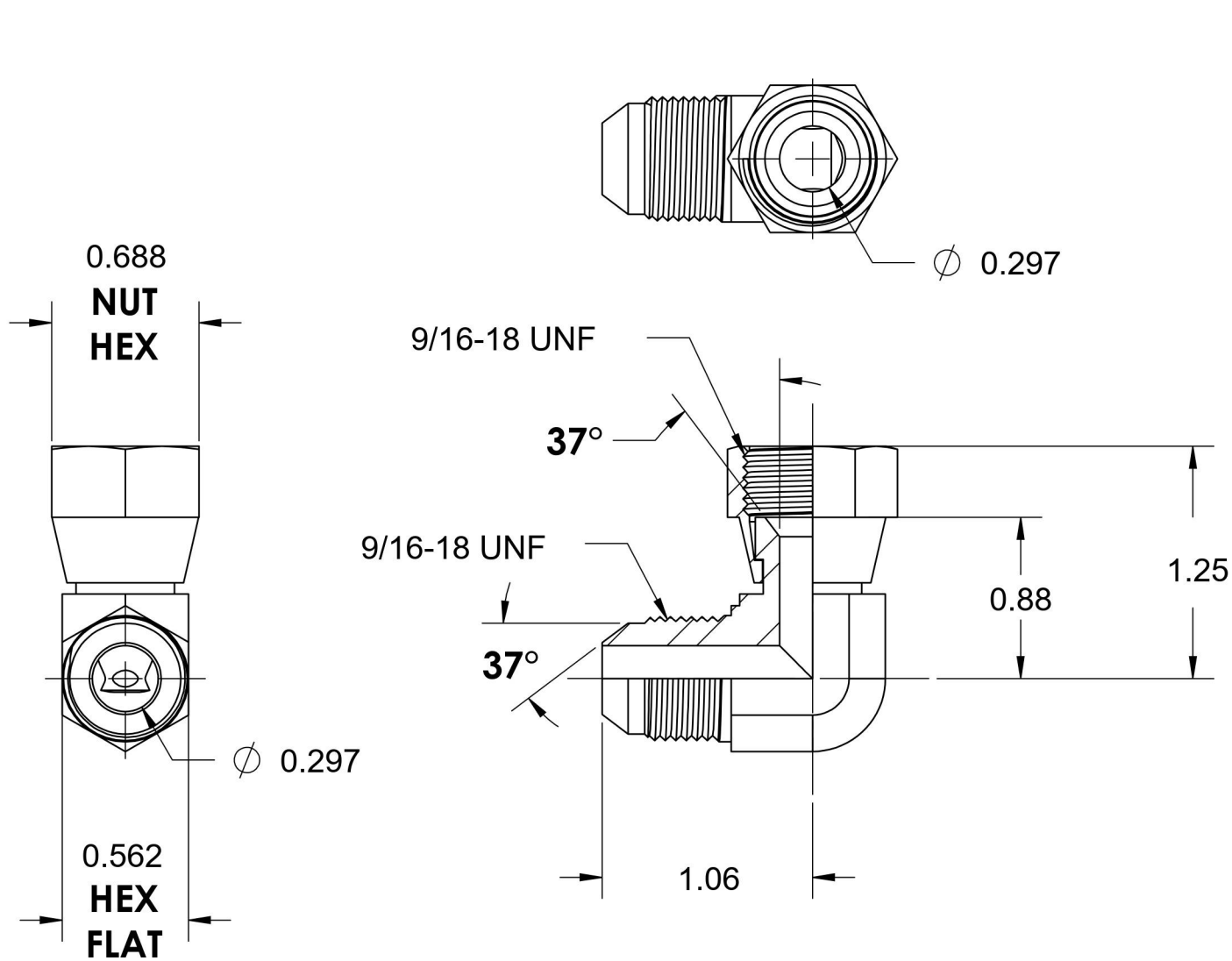

6701 Cochran Road
Solon, Ohio 44139
Phone: (440) 248-1880
Toll Free: 1-888-331-1523

Temperature Rating -425°F to 1200°F	Material 316/316L Stainless Steel	Industry Standards SAE J514	Series 6500-SS
Pressure Rating 6000 psi	Finish Passivated		Series Description SAE J514 37° Flare 90° Swivel Elbow