

7005-04-L08-14-SS

Stainless Steel, SAE J514 37° Flare DIN 2353 (Light) Tube Adapter Body Only, 1/4" Male JIC x M14X1.5 Male DIN

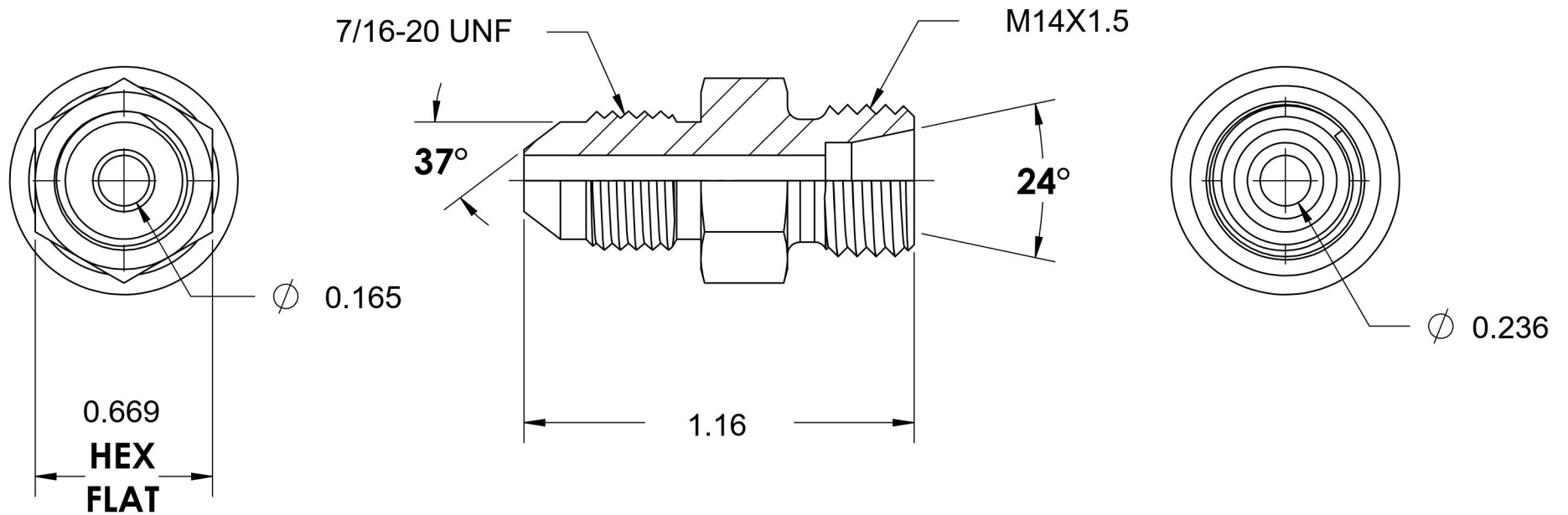

6701 Cochran Road
Solon, Ohio 44139
Phone: (440) 248-1880
Toll Free: 1-888-331-1523

| | | | |
|---------------------------|--------------------------|---------------------------|--|
| Temperature Rating | Material | Industry Standards | Series |
| -425°F to 1200°F | 316/316L Stainless Steel | SAE J514, ISO 8434-1 | 7005-DIN LIGHT-SS |
| Pressure Rating | Finish | DIN 2353 | Series Description |
| 7250 psi | Passivated | | SAE J514 37° Flare DIN 2353 (Light) Tube Adapter Body Only |