

6803-10-10-10-NWO-FG-VITON

Steel, SAE J514 37° Flare Adjustable Port Branch Tee, 5/8" Male JIC x 5/8" Male JIC x 7/8-14 Male Adjustable ORB, FKM Seal

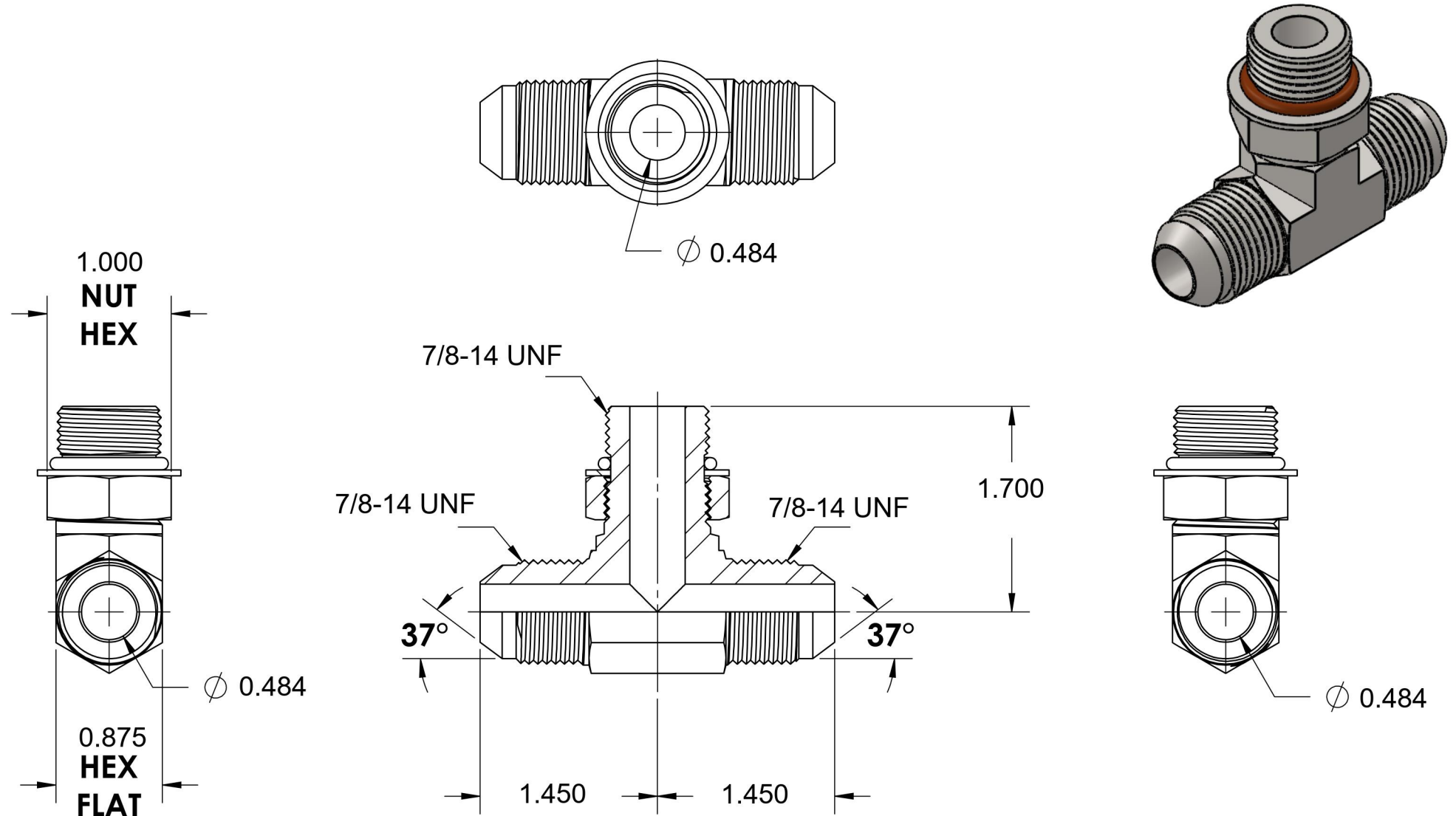

6701 Cochran Road
Solon, Ohio 44139
Phone: (440) 248-1880
Toll Free: 1-888-331-1523

Temperature Rating

-15°F to 400°F

Pressure Rating

5000 psi

Material

C1045 Steel

Finish

Trivalent Zinc

Industry Standards

SAE J514, SAE J1926-3
SAE J515, ASTM B633

Series

6803-NWO-FG-VITON

Series Description

SAE J514 37° Flare Adjustable
Port Branch Tee