

2705-LN-16-16

Steel, SAE J514 Flared Tube Female Bulkhead, 1" Female NPTF x 1" Male JIC

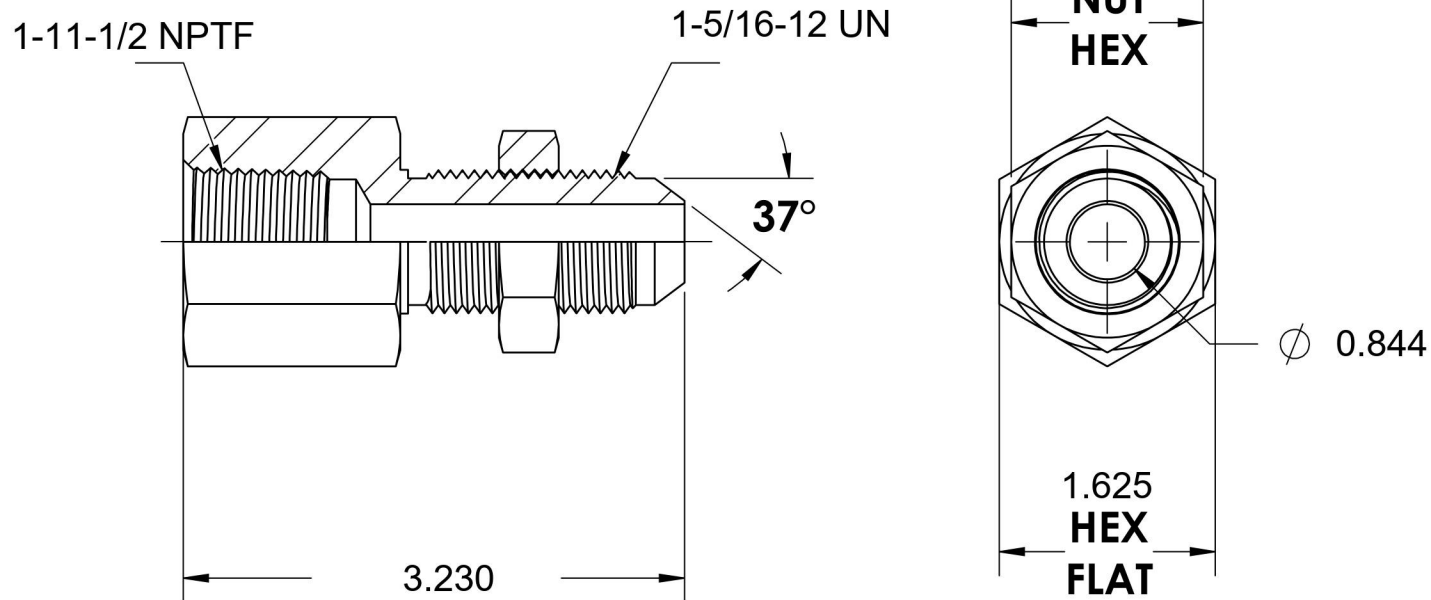
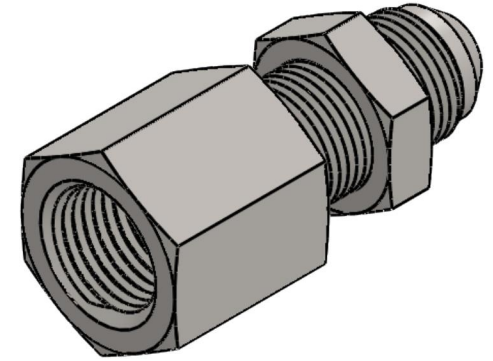

6701 Cochran Road
Solon, Ohio 44139
Phone: (440) 248-1880
Toll Free: 1-888-331-1523

Temperature Rating -65°F to 500°F	Material C1045/12L14 Steel	Industry Standards SAE J514 , SAE J476 ASTM B633	Series 2705-LN
Pressure Rating 3000 psi	Finish Trivalent Zinc		Series Description SAE J514 Flared Tube Female Bulkhead