

6900-32-32-O-SS

Stainless Steel, SAE J514 NPSM Swivel Port Connector, 2-1/2-12 Male ORB x 2" Female NPSM Swivel

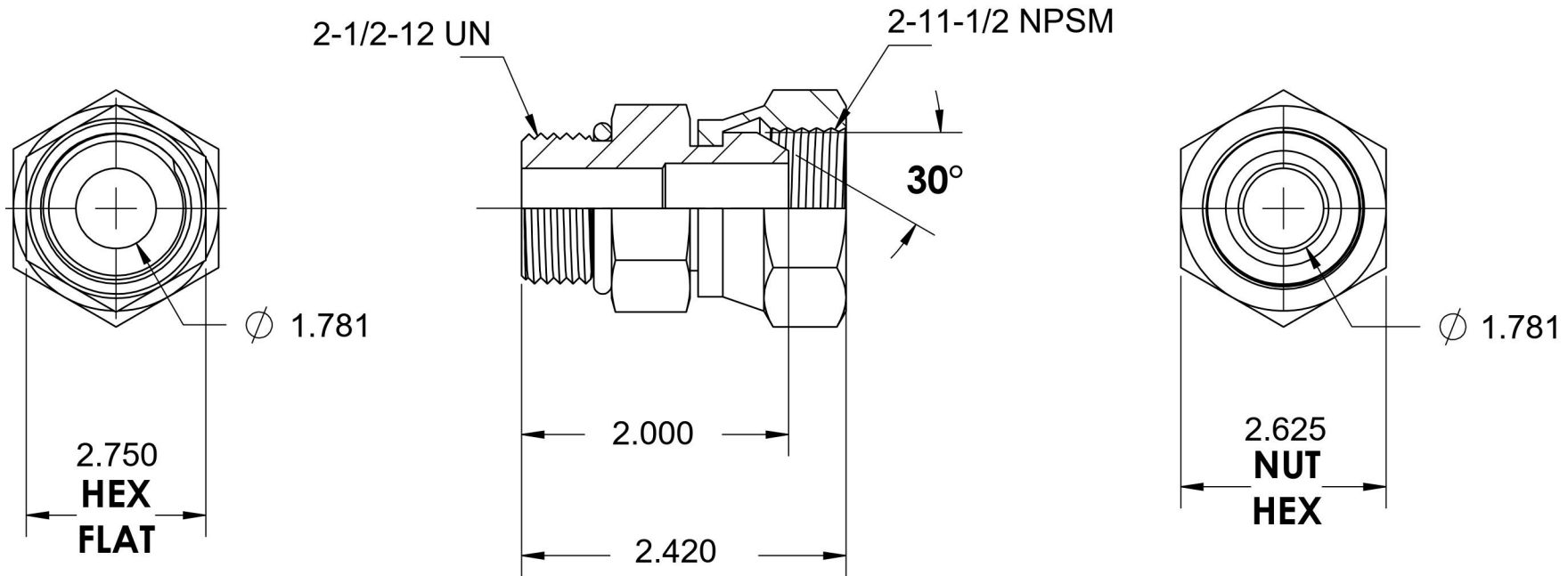
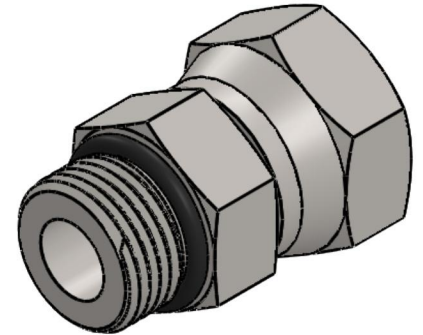

6701 Cochran Road
Solon, Ohio 44139
Phone: (440) 248-1880
Toll Free: 1-888-331-1523

Temperature Rating	Material	Industry Standards	Series
-40°F to 250°F	316/316L Stainless Steel	SAE J514, SAE J476 SAE J1926-3, SAE J515	6900-O-SS
Pressure Rating	Finish		Series Description
1500 psi	Passivated		SAE J514 NPSM Swivel Port Connector