

2702-LN-16-16-SS

Stainless Steel, SAE J514 37° Flare Bulkhead 45° Elbow With Lock Nut, 1" Male JIC x 1" Male JIC

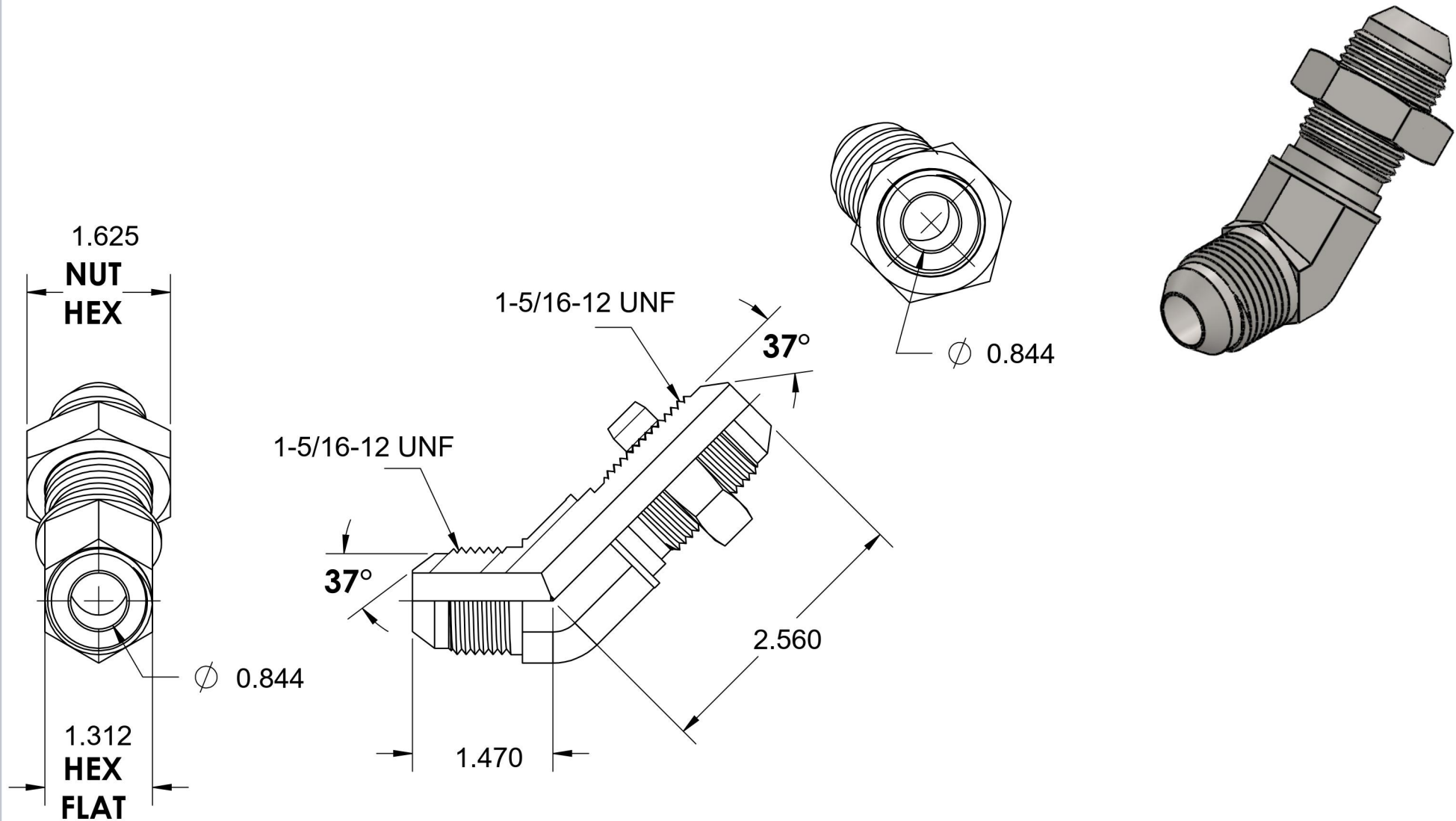

6701 Cochran Road
Solon, Ohio 44139
Phone: (440) 248-1880
Toll Free: 1-888-331-1523

Temperature Rating	Material	Industry Standards	Series
-425°F to 1200°F	316/316L Stainless	SAE J514	2702-LN-FG
Pressure Rating	Finish		Series Description
3500 psi	Passivation		SAE J514 37° Flare Bulkhead 45° Elbow With Lock Nut