

6600-24-24-24-FG

Steel, SAE J514 37° Flare Swivel Branch Tee, 1-1/2" Male JIC x 1-1/2" Male JIC x 1-1/2" Female JIC Swivel

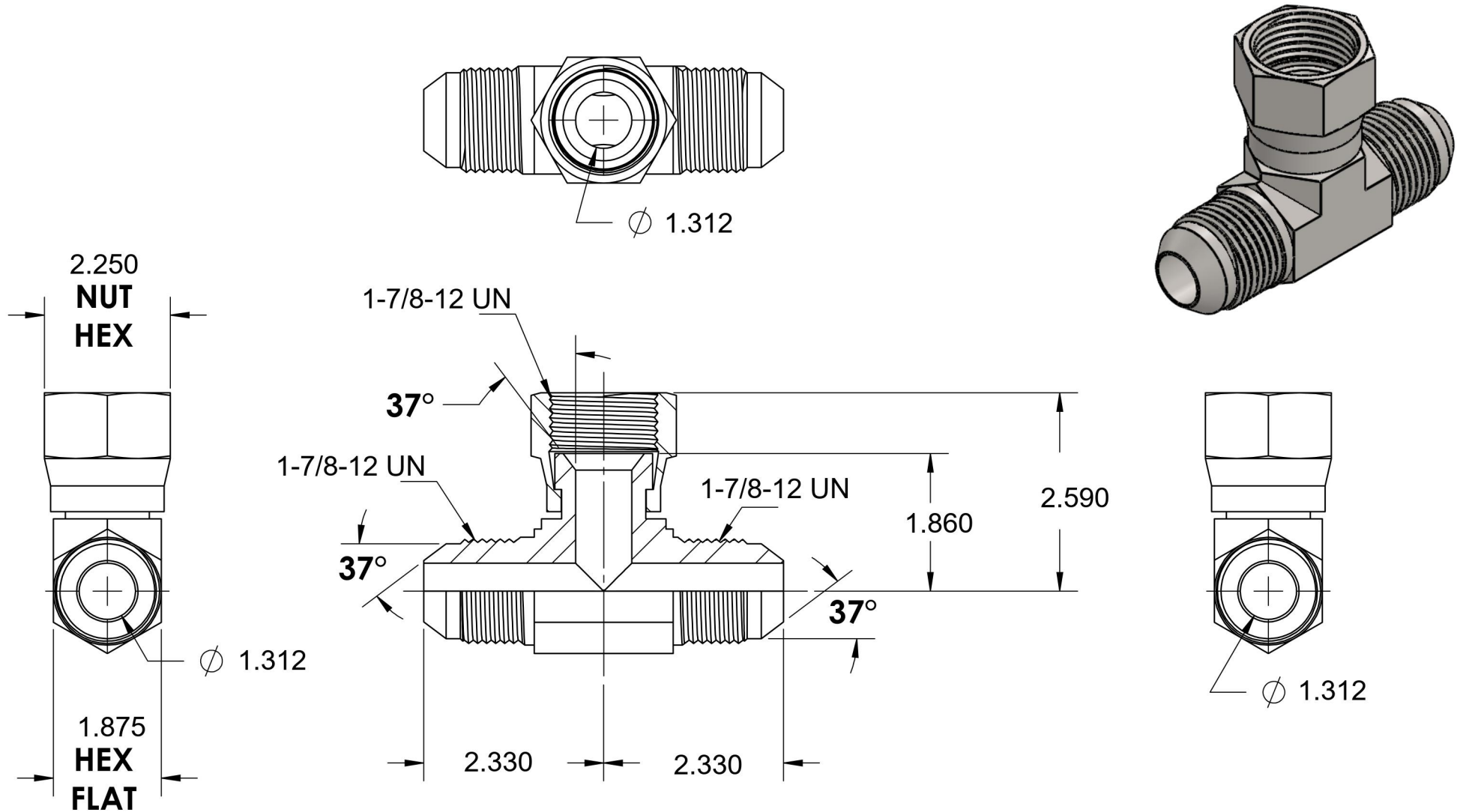

6701 Cochran Road
Solon, Ohio 44139
Phone: (440) 248-1880
Toll Free: 1-888-331-1523

Temperature Rating

-65°F to 500°F

Pressure Rating

3000 psi

Material

C1045 Steel

Finish

Trivalent Zinc

Industry Standards

SAE J514, ASTM B633

Series

6600-FG

Series Description

SAE J514 37° Flare Swivel Branch Tee