

5502-02-02-FG-B

Brass, SAE J514 Pipe 90° Street Elbow, 1/8" Male NPTF 30° x 1/8" Female NPTF

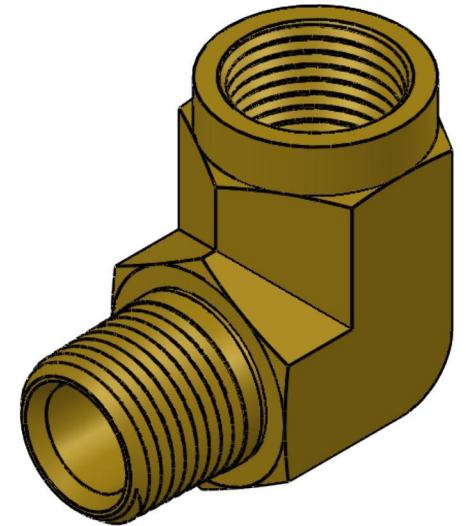
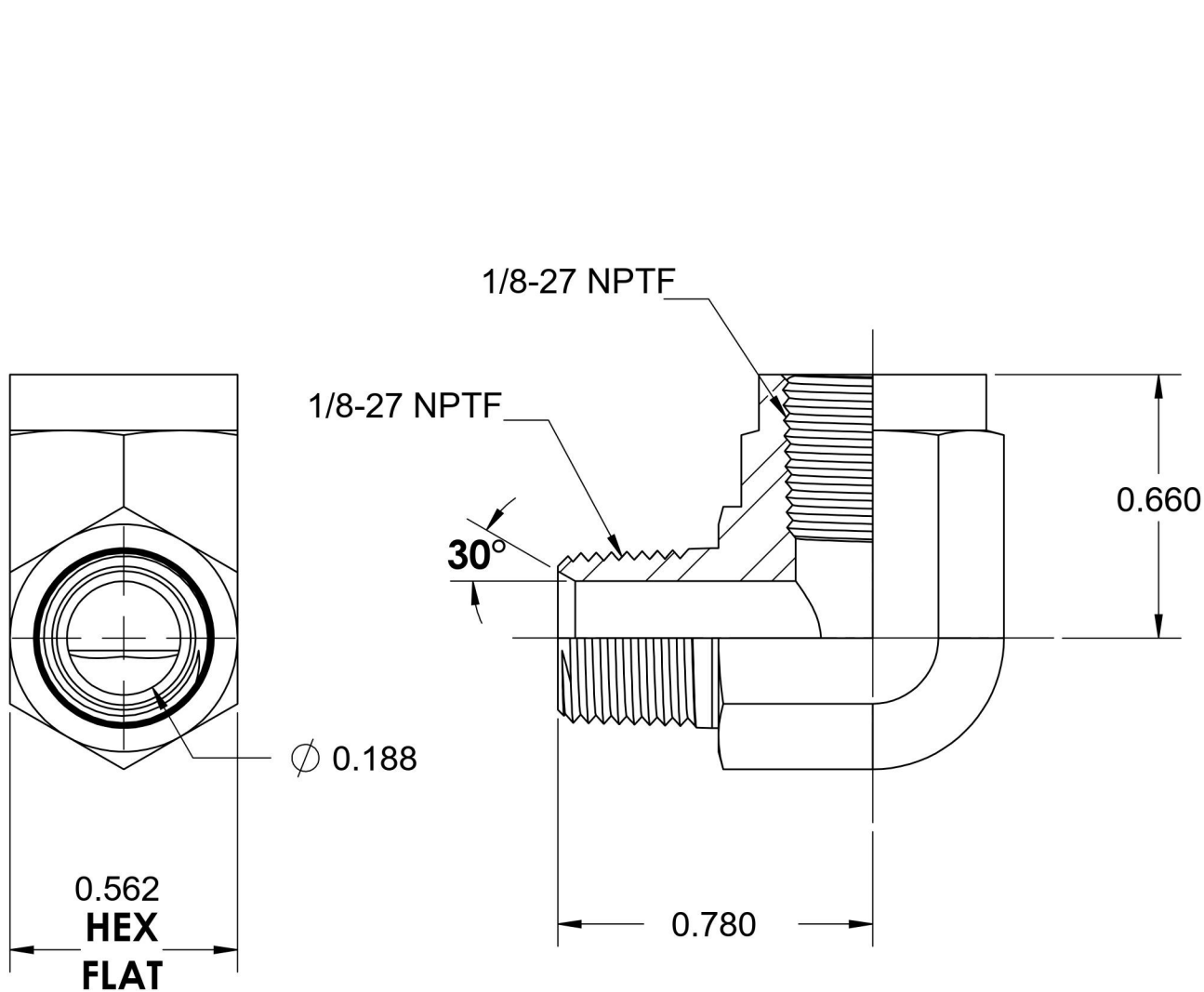

6701 Cochran Road
Solon, Ohio 44139
Phone: (440) 248-1880
Toll Free: 1-888-331-1523

Temperature Rating -325°F to 400°F	Material CA37700 Brass	Industry Standards SAE J514 , SAE J476	Series 5502-B
Pressure Rating 3200 psi	Finish Natural Finish		Series Description SAE J514 Pipe 90° Street Elbow