

2406-20-08

Steel, SAE J514 37° Flare Reducer, 1-1/4" Female JIC x 1/2" Male JIC

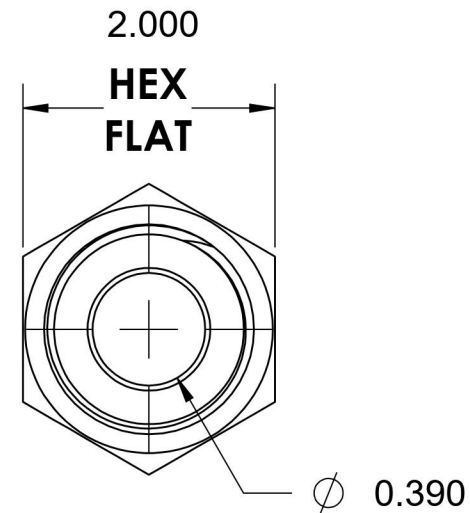
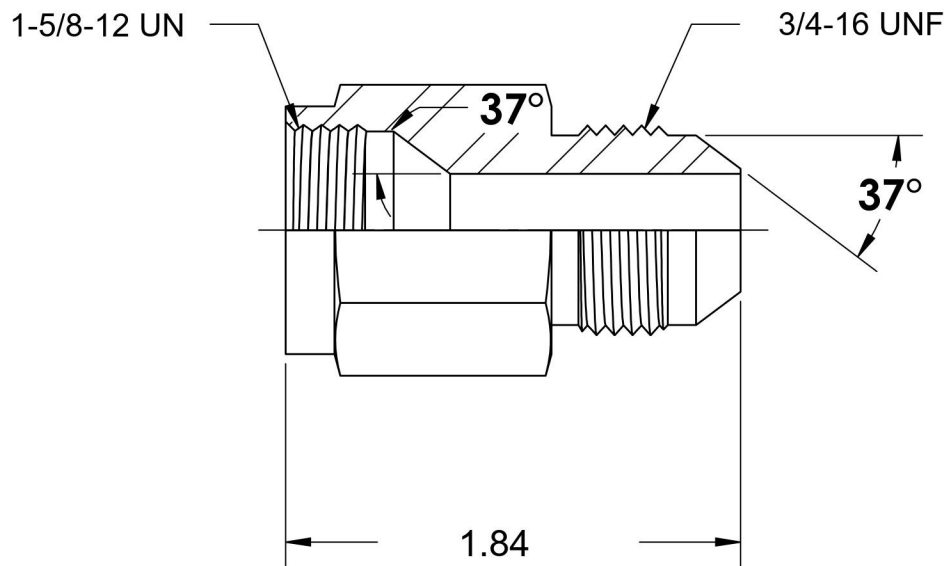

6701 Cochran Road
Solon, Ohio 44139
Phone: (440) 248-1880
Toll Free: 1-888-331-1523

Temperature Rating -65°F to 500°F	Material C1045/12L14 Steel	Industry Standards SAE J514, ASTM B633	Series 2406
Pressure Rating 4000 psi	Finish Trivalent Zinc		Series Description SAE J514 37° Flare Reducer