

# 6574-08-08-04

Steel, SAE J514 37° Flare Swivel Adapter NPT Diagnostic Port, 1/2" Male JIC x 1/2" Female JIC Swivel x 1/4" FNPT Diagnostic Port

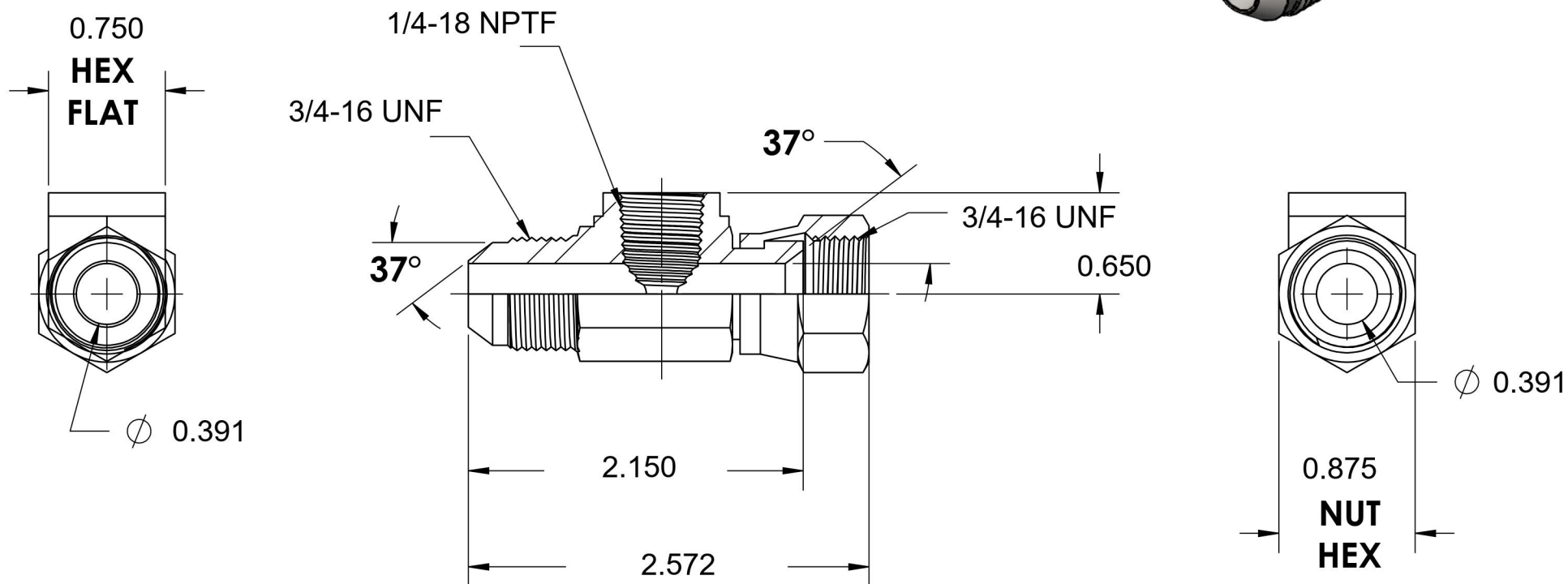
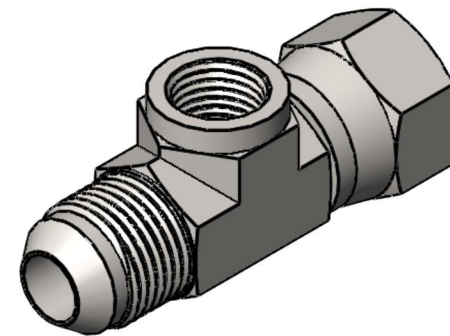

6701 Cochran Road  
Solon, Ohio 44139  
Phone: (440) 248-1880  
Toll Free: 1-888-331-1523

**Temperature Rating**

-65°F to 500°F

**Pressure Rating**

4500 psi

**Material**

C1045/12L14 Steel

**Finish**

Trivalent Zinc

**Industry Standards**

SAE J514, SAE J1926-1  
ASTM B633

**Series**

6574

**Series Description**

SAE J514 37° Flare Swivel Adapter  
NPT Diagnostic Port