

# D2408-S08-X

Steel, DIN 2353 Plug, Heavy 8mm Tube OD, Body Only

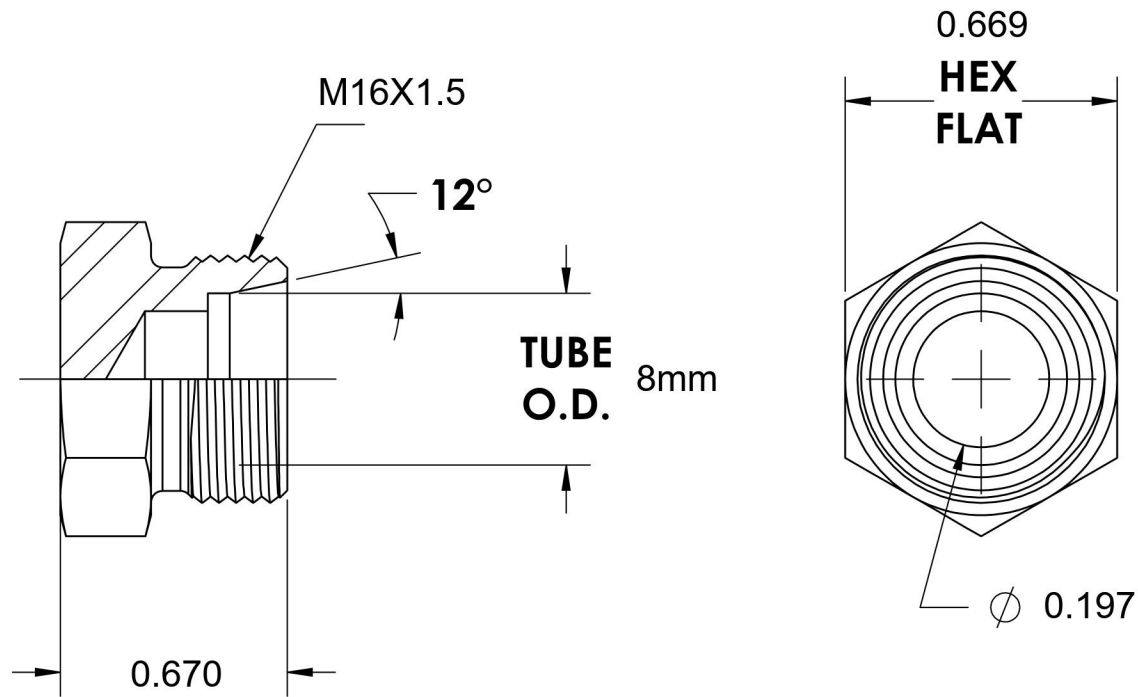
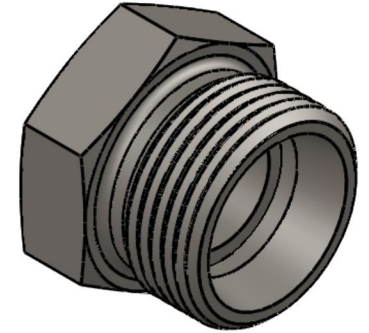

6701 Cochran Road  
Solon, Ohio 44139  
Phone: (440) 248-1880  
Toll Free: 1-888-331-1523

**Temperature Rating**

-65°F to 500°F

**Pressure Rating**

11603 psi

**Material**

C22 Steel

**Finish**

Zinc Nickel

**Industry Standards**

DIN 2353, ISO 8434-1

**Series**

D2408-X

**Series Description**

DIN 2353 Flareless  
Tube Plug, Body Only