

2408-04

Steel, SAE J514 37° Flare Plug, 1/4" Male JIC

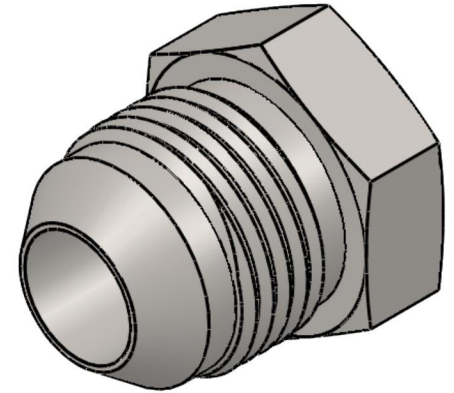
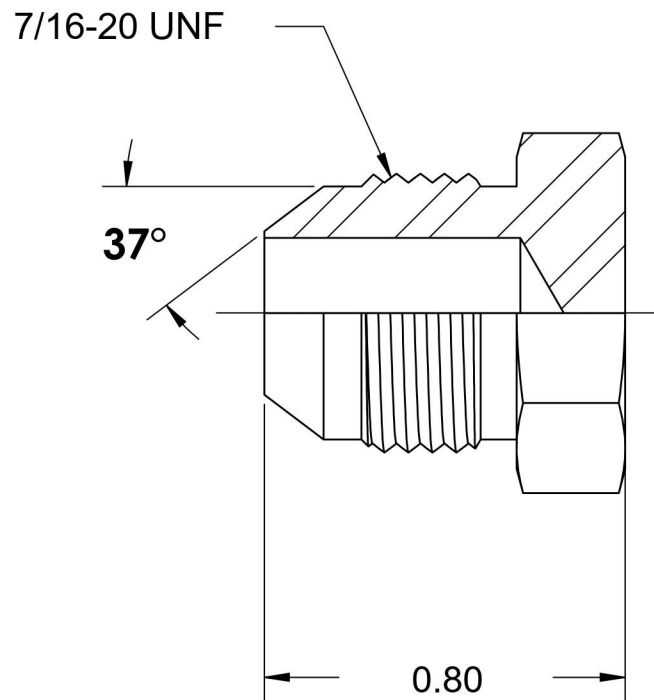
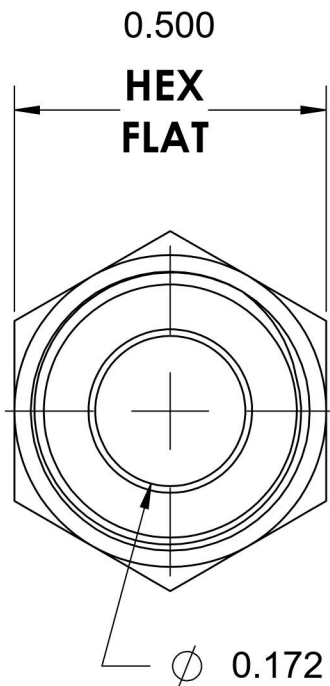

6701 Cochran Road
Solon, Ohio 44139
Phone: (440) 248-1880
Toll Free: 1-888-331-1523

Temperature Rating

-65°F to 500°F

Pressure Rating

7500 psi

Material

C1045/12L14 Steel

Finish

Trivalent Zinc

Industry Standards

SAE J514, ASTM B633

Series

2408

Series Description

SAE J514 37° Flare Plug