

7000-06-08-SS

Stainless Steel, SAE J514 37° Flare Male BSPT Connector, 3/8" Male JIC x 1/2" Male BSPT 30°

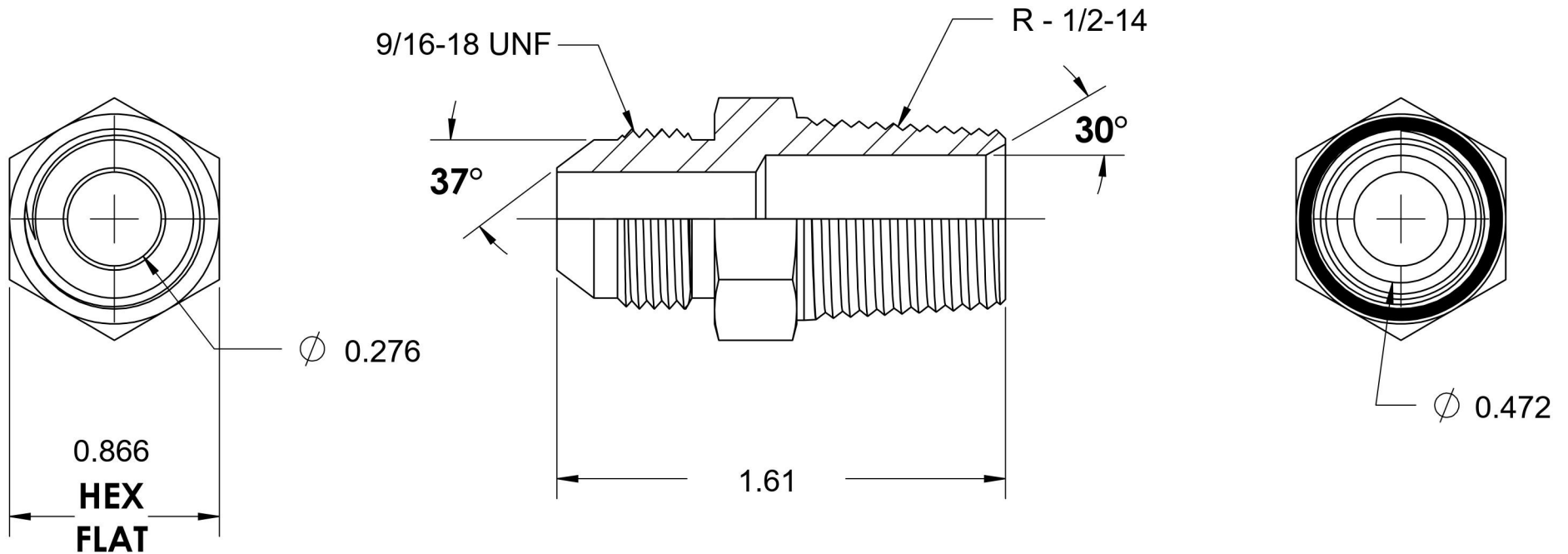

6701 Cochran Road
Solon, Ohio 44139
Phone: (440) 248-1880
Toll Free: 1-888-331-1523

Temperature Rating	Material	Industry Standards	Series
-425°F to 1200°F	316/316L Stainless Steel	SAE J514, ISO 7-1	7000-SS
Pressure Rating	Finish		Series Description
4500 psi	Passivated		SAE J514 37° Flare Male BSPT Connector