

6802-12-08-NWO-SS

Stainless Steel, SAE J514 37° Flare 45° Adjustable Port Elbow, 3/4" Male JIC x 3/4-16 Male Adjustable ORB

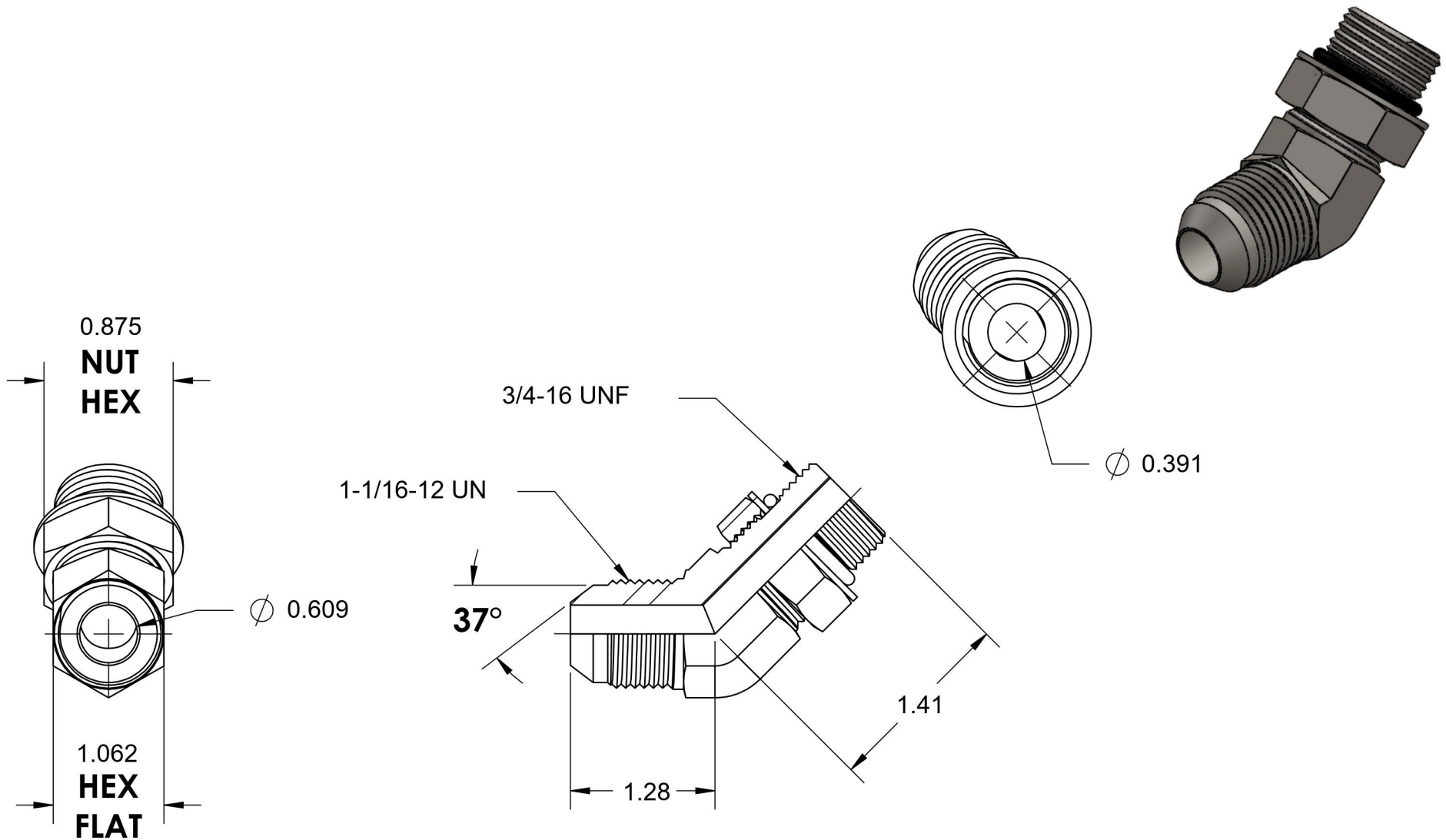

6701 Cochran Road
Solon, Ohio 44139
Phone: (440) 248-1880
Toll Free: 1-888-331-1523

Temperature Rating -40°F to 250°F	Material 316/316L Stainless Steel	Industry Standards SAE J514, SAE J1926-3 SAE J515	Series 6802-NWO-SS
Pressure Rating 5400 psi	Finish Passivated		Series Description SAE J514 37° Flare 45° Adjustable Port Elbow