

9522-P-16

Steel, ISO 1179 BSPP Hex Head Port Plug, 1-11 Male BSPP 60° Line/Port

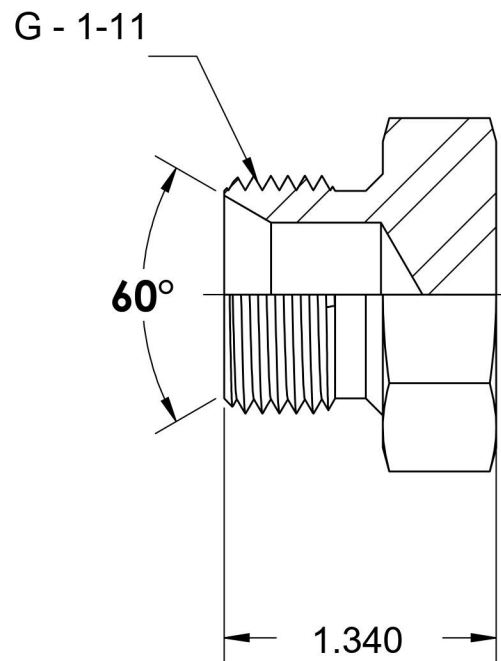
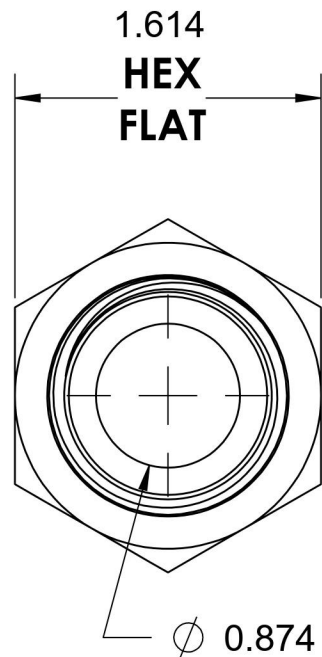
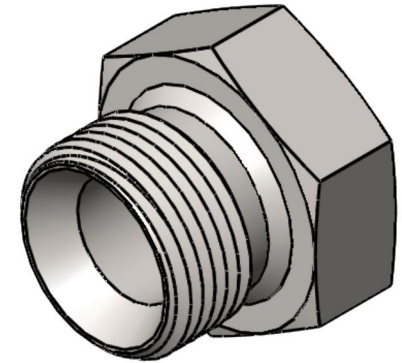

6701 Cochran Road
Solon, Ohio 44139
Phone: (440) 248-1880
Toll Free: 1-888-331-1523

Temperature Rating

-65°F to 500°F

Pressure Rating

1700 psi

Material

C1045/12L14 Steel

Finish

Trivalent Zinc

Industry Standards

ISO 1179, ASTM B633

Series

9522-P

Series Description

ISO 1179 BSPP Hex Head Port Plug