

0304-C-14

Steel, SAE J514 37° Flare Tube Cap, 7/8" Female JIC

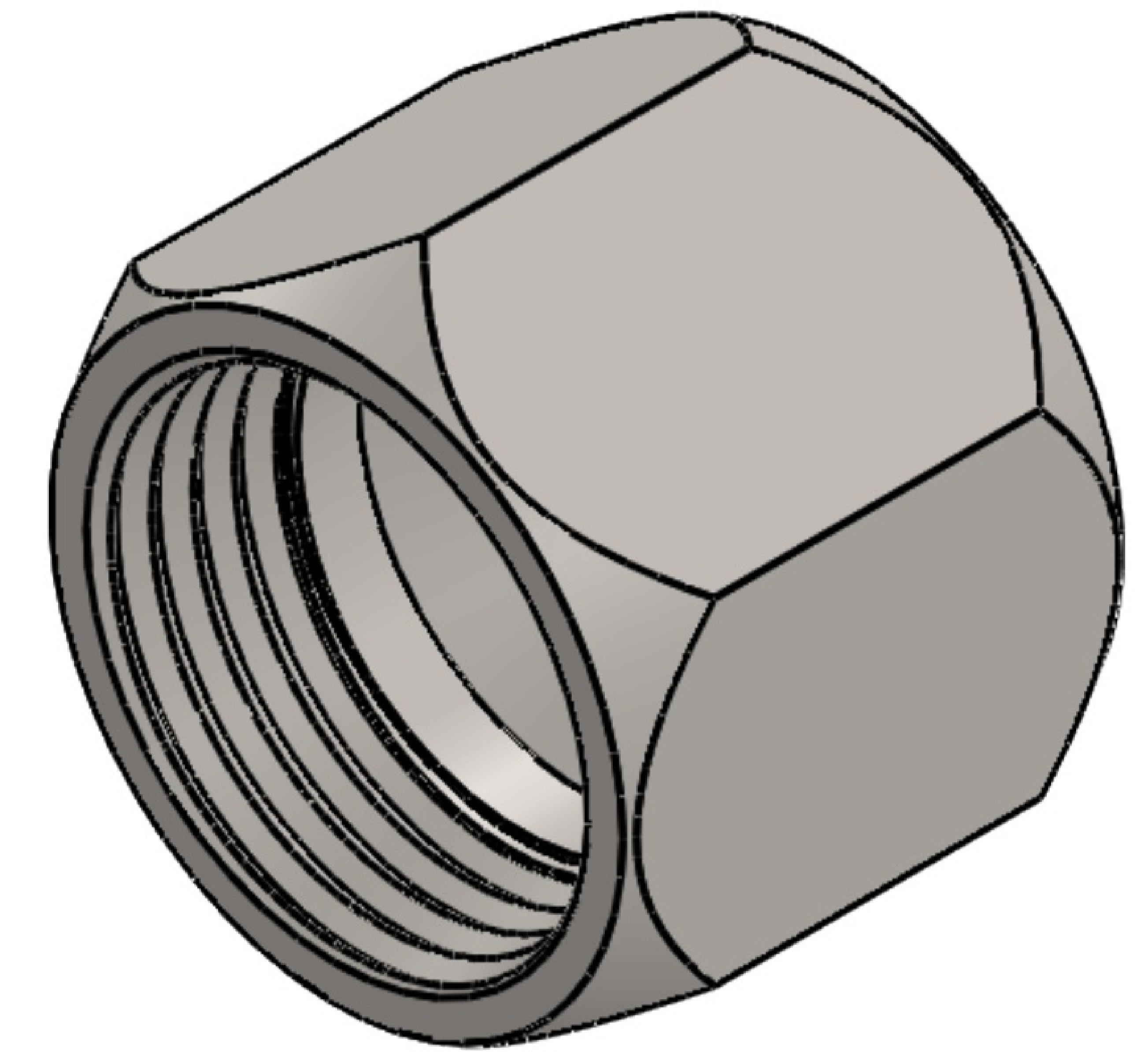
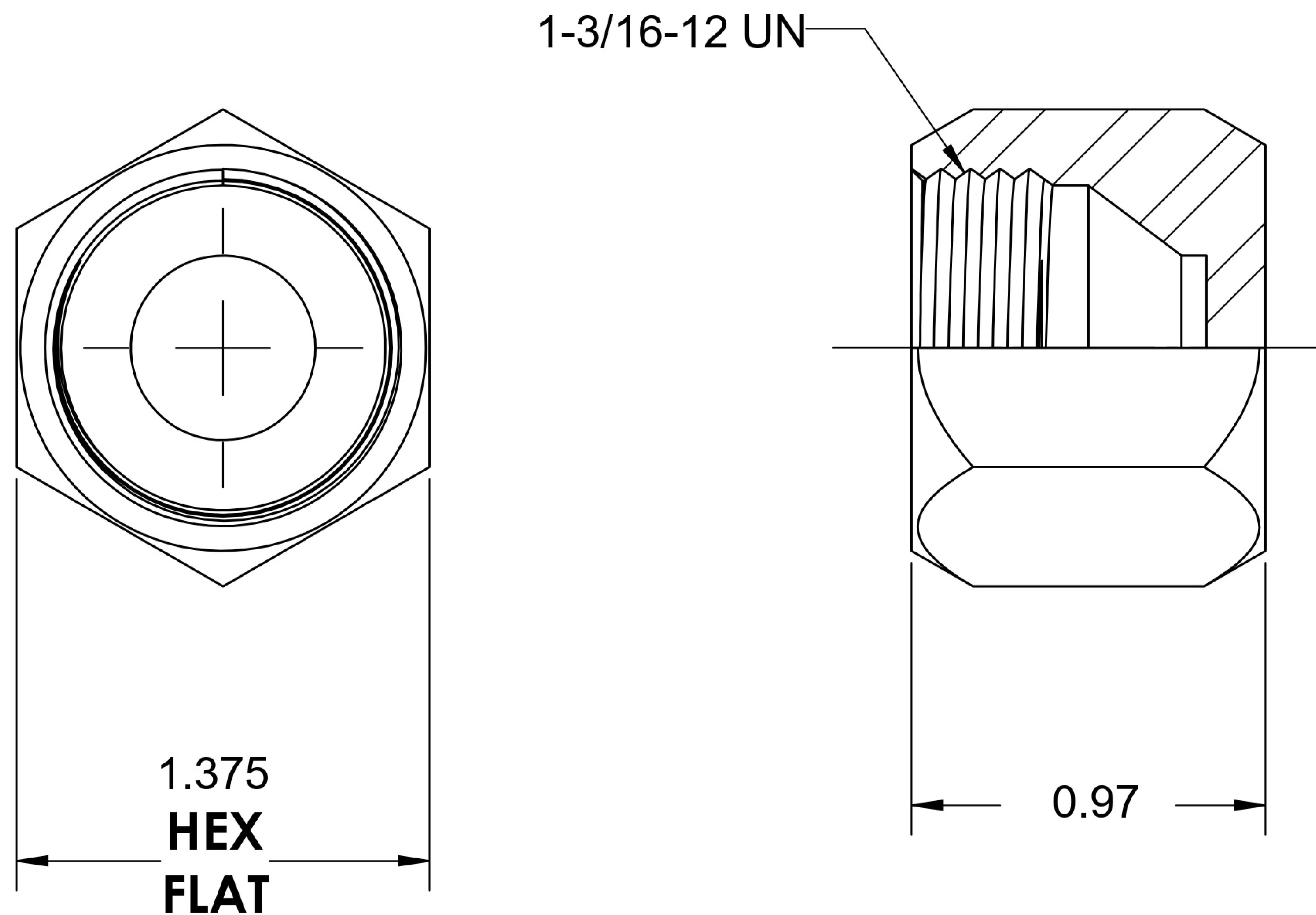

6701 Cochran Road
Solon, Ohio 44139
Phone: (440) 248-1880
Toll Free: 1-888-331-1523

Temperature Rating -65°F to 500°F	Material C1045 Steel	Industry Standards SAE J514, ASTM B633	Series 0304-C
Pressure Rating 5000 psi	Finish Trivalent Zinc		Series Description SAE J514 37° Flare Tube Cap