

# 6502-06-06-SS

Stainless Steel, SAE J514 37° Flare 45° Swivel Elbow, 3/8" Male JIC x 3/8" Female JIC Swivel

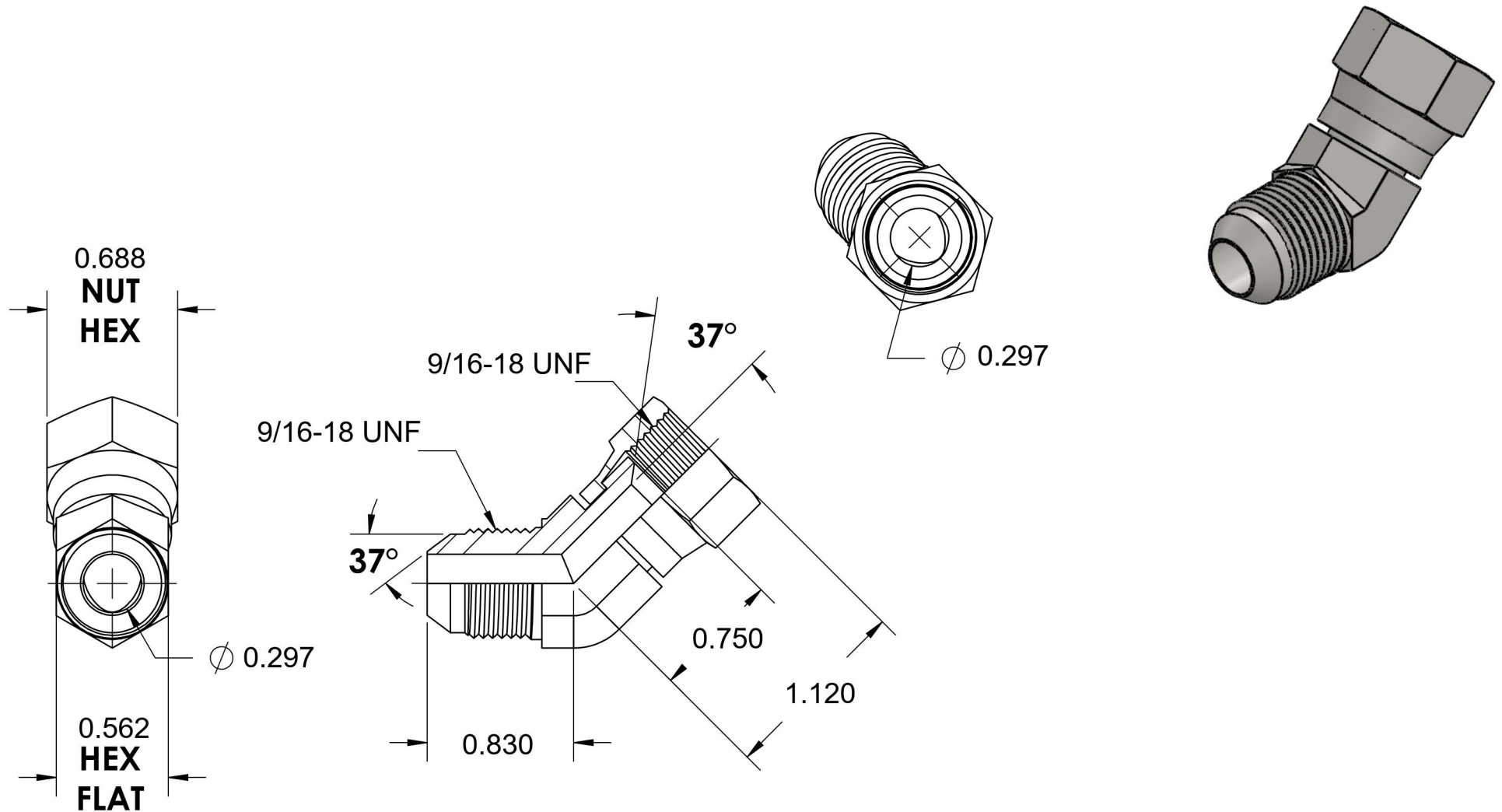

6701 Cochran Road  
Solon, Ohio 44139  
Phone: (440) 248-1880  
Toll Free: 1-888-331-1523

Temperature Rating	-425°F to 1200°F	Material	316/316L Stainless Steel	Industry Standards	SAE J514	Series	6502-SS
Pressure Rating	6000 psi	Finish	Passivated			Series Description	SAE J514 37° Flare 45° Swivel Elbow