

# 2500-12-10-SS

Stainless Steel, SAE J514 37° Flare 90° Union Elbow, 3/4" Male JIC x 5/8" Male JIC

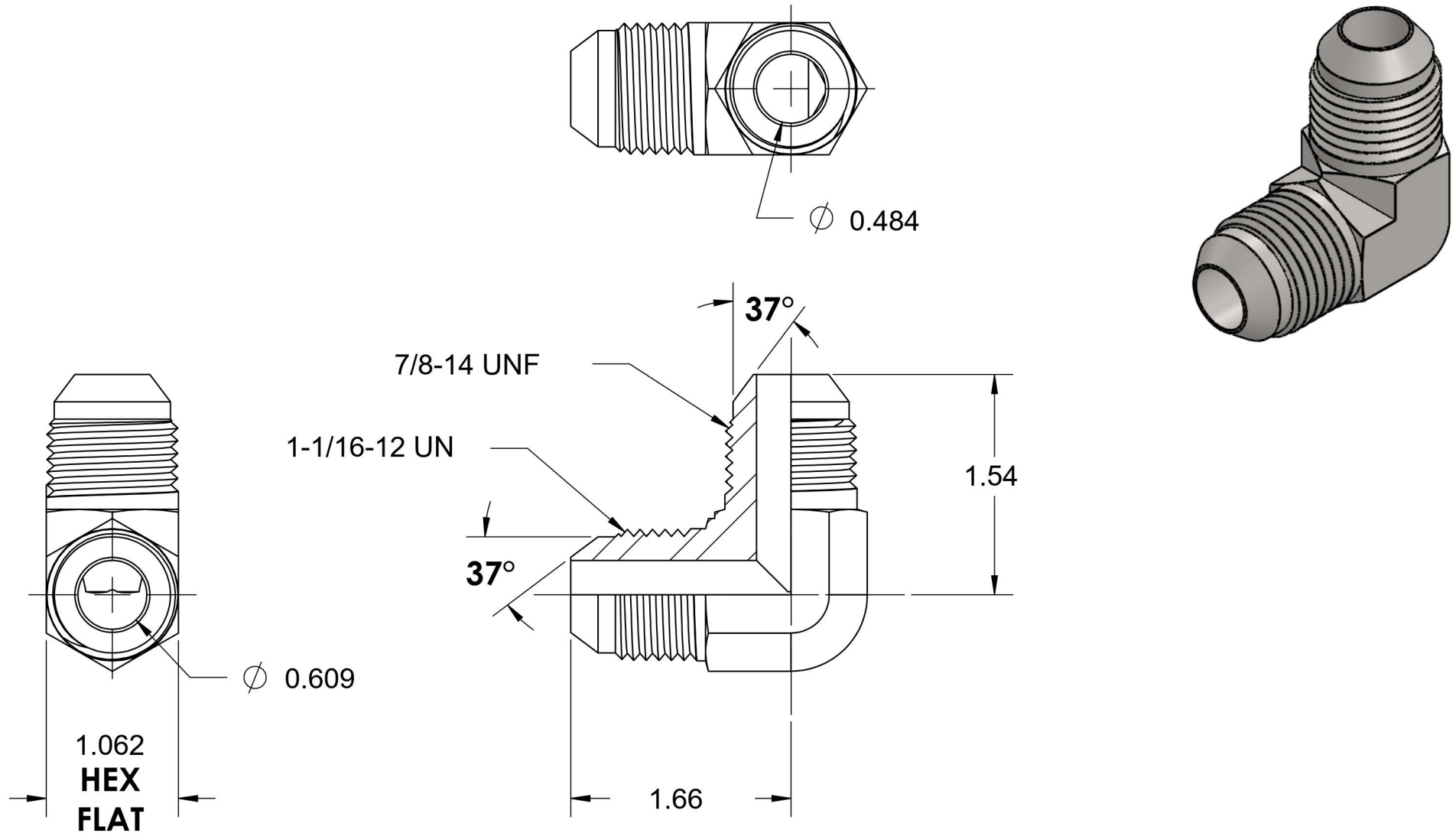

6701 Cochran Road  
Solon, Ohio 44139  
Phone: (440) 248-1880  
Toll Free: 1-888-331-1523

<b>Temperature Rating</b> -425°F to 1200°F	<b>Material</b> 316/316L Stainless Steel	<b>Industry Standards</b> SAE J514	<b>Series</b> 2500-SS
<b>Pressure Rating</b> 5000 psi	<b>Finish</b> Passivated		<b>Series Description</b> SAE J514 37° Flare 90° Union Elbow