

7001-06-16-SS

Stainless Steel, SAE J514 37° Flare Male Metric Type (G) Port Adapter, 3/8" Male JIC x M16X1.5 Male Metric ORR

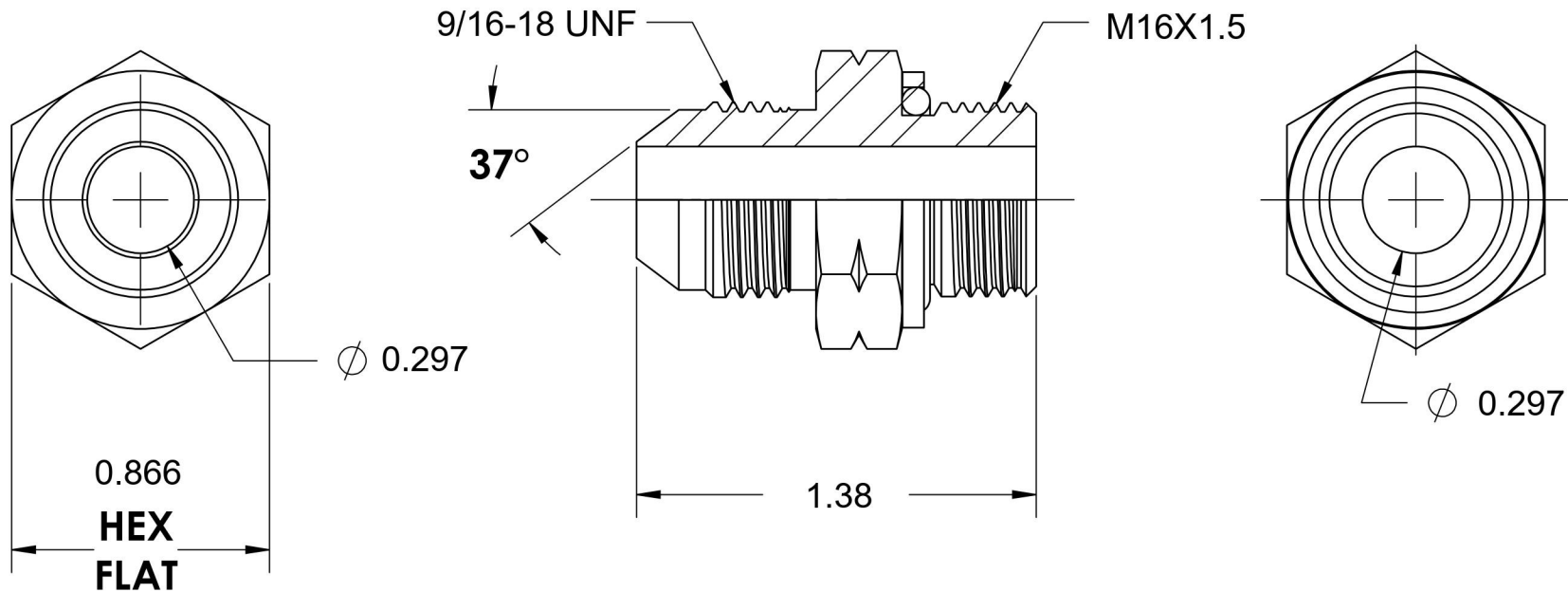

6701 Cochran Road
Solon, Ohio 44139
Phone: (440) 248-1880
Toll Free: 1-888-331-1523

Temperature Rating	Material	Industry Standards	Series
-22°F to 257°F	316/316L Stainless Steel	SAE J514, ISO 9974	7001-ORR-SS
Pressure Rating	Finish		Series Description
5000 psi	Passivated		SAE J514 37° Flare Male Metric Type (G) Port Adapter