

6801-L-05-04-NWO-FG

Steel, SAE J514 37° Flare 90° Long Adjustable Port Elbow, 5/16" Male JIC x 7/16-20 Male Adjustable ORB

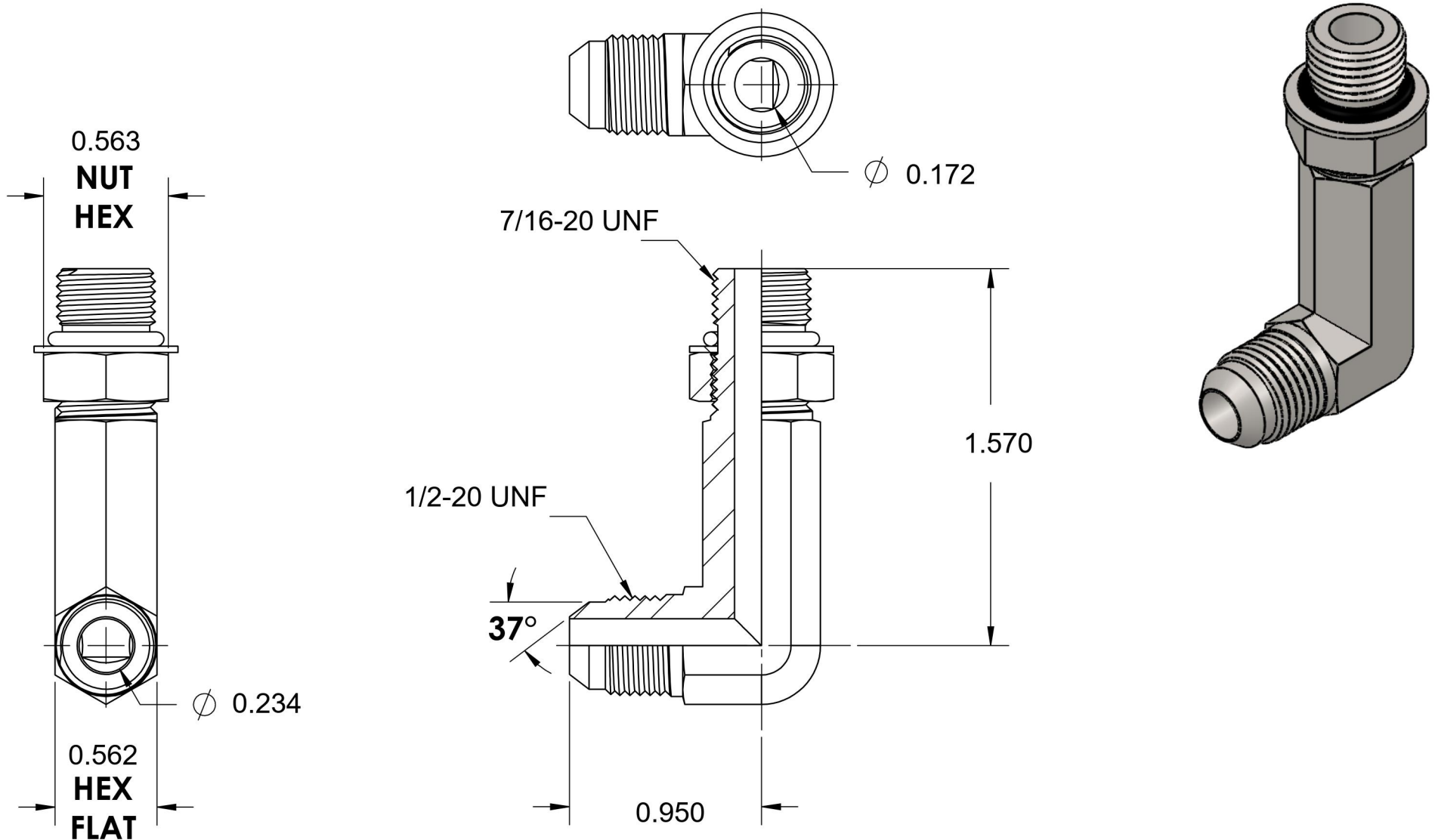

6701 Cochran Road
Solon, Ohio 44139
Phone: (440) 248-1880
Toll Free: 1-888-331-1523

Temperature Rating	Material	Industry Standards	Series
-40°F to 250°F	C1045 Steel	SAE J514, SAE J1926-3 ASTM B633	6801-L-NWO-FG
Pressure Rating	Finish		Series Description
6000psi	Trivalent Zinc		SAE J514 37° Flare 90° Long Adjustable Port Elbow