

0306-03

Steel, SAE J514 37° Flare Bulkhead Lock Nut, 3/16" Male JIC

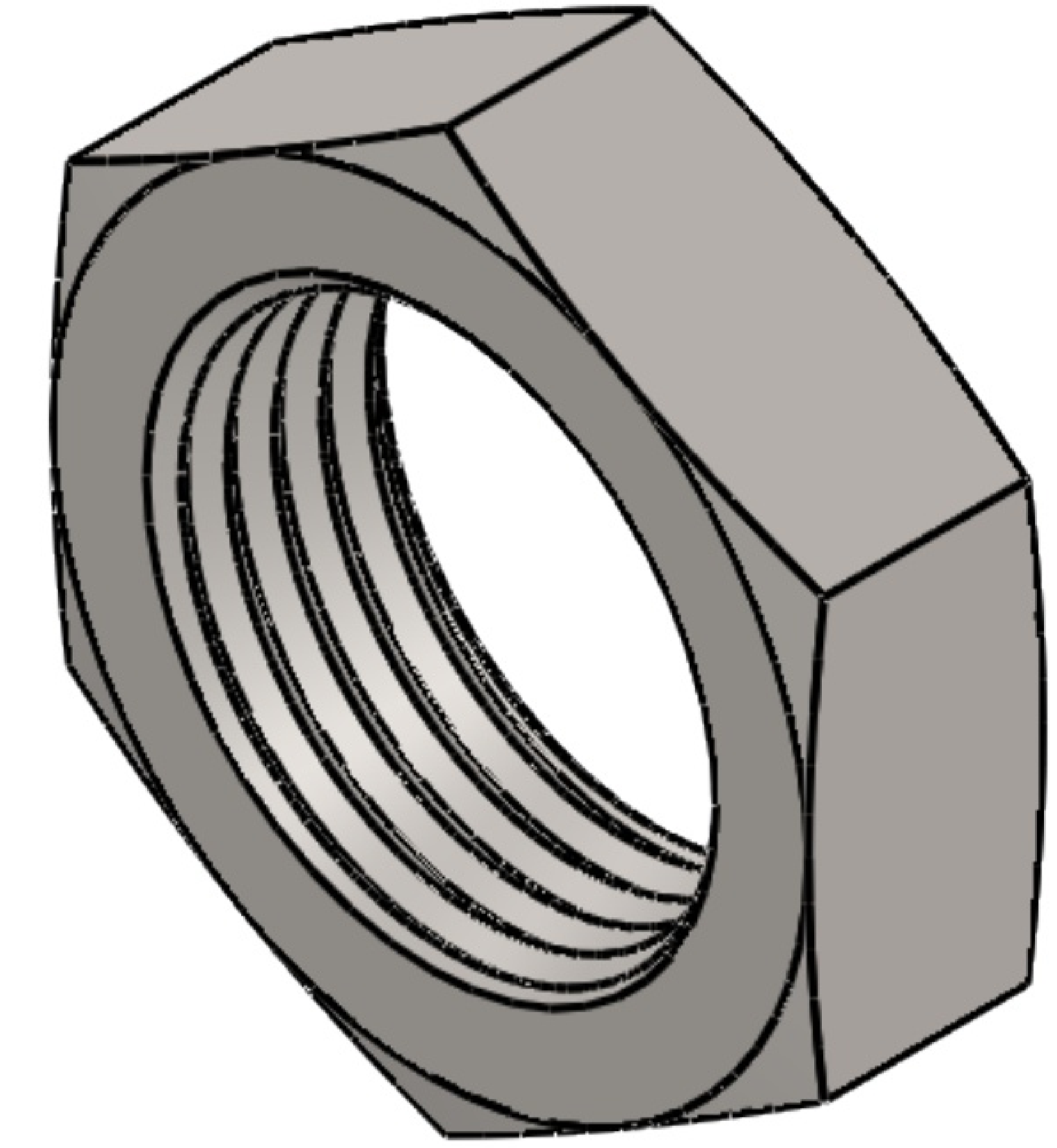
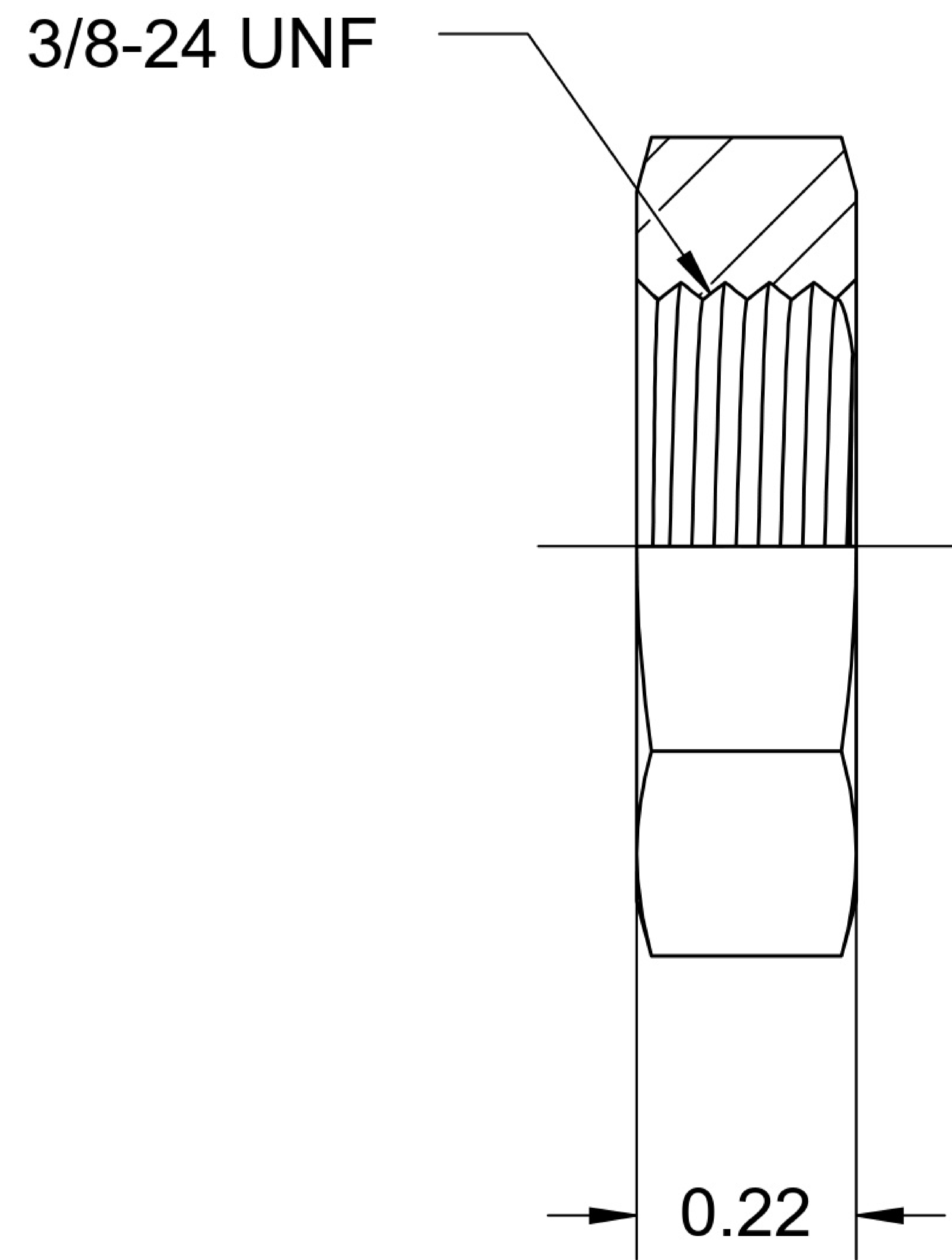
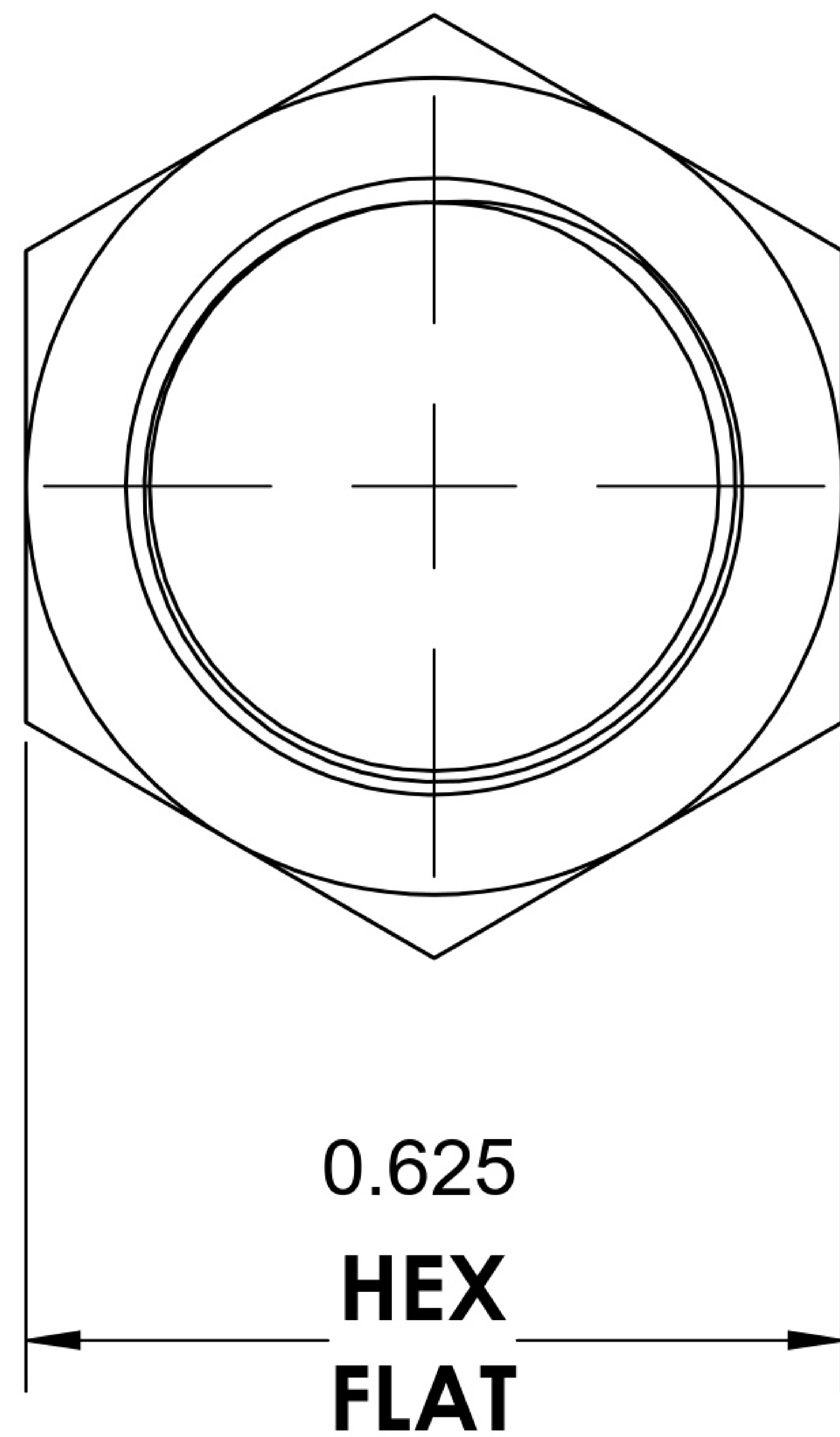

6701 Cochran Road
Solon, Ohio 44139
Phone: (440) 248-1880
Toll Free: 1-888-331-1523

Temperature Rating

-65°F to 500°F

Pressure Rating

Not Applicable

Material

C1045 Steel

Finish

Trivalent Zinc

Industry Standards

SAE J514, ASTM B633

Series

0306

Series Description

SAE J514 37° Flare Bulkhead Lock Nut