

6804-08-08-08-NWO-FG-VITON

Steel, SAE J514 37° Flare Adjustable Port Run Tee, 1/2" Male JIC x 3/4-16 Male Adjustable ORB x 1/2" Male JIC, FKM Seal

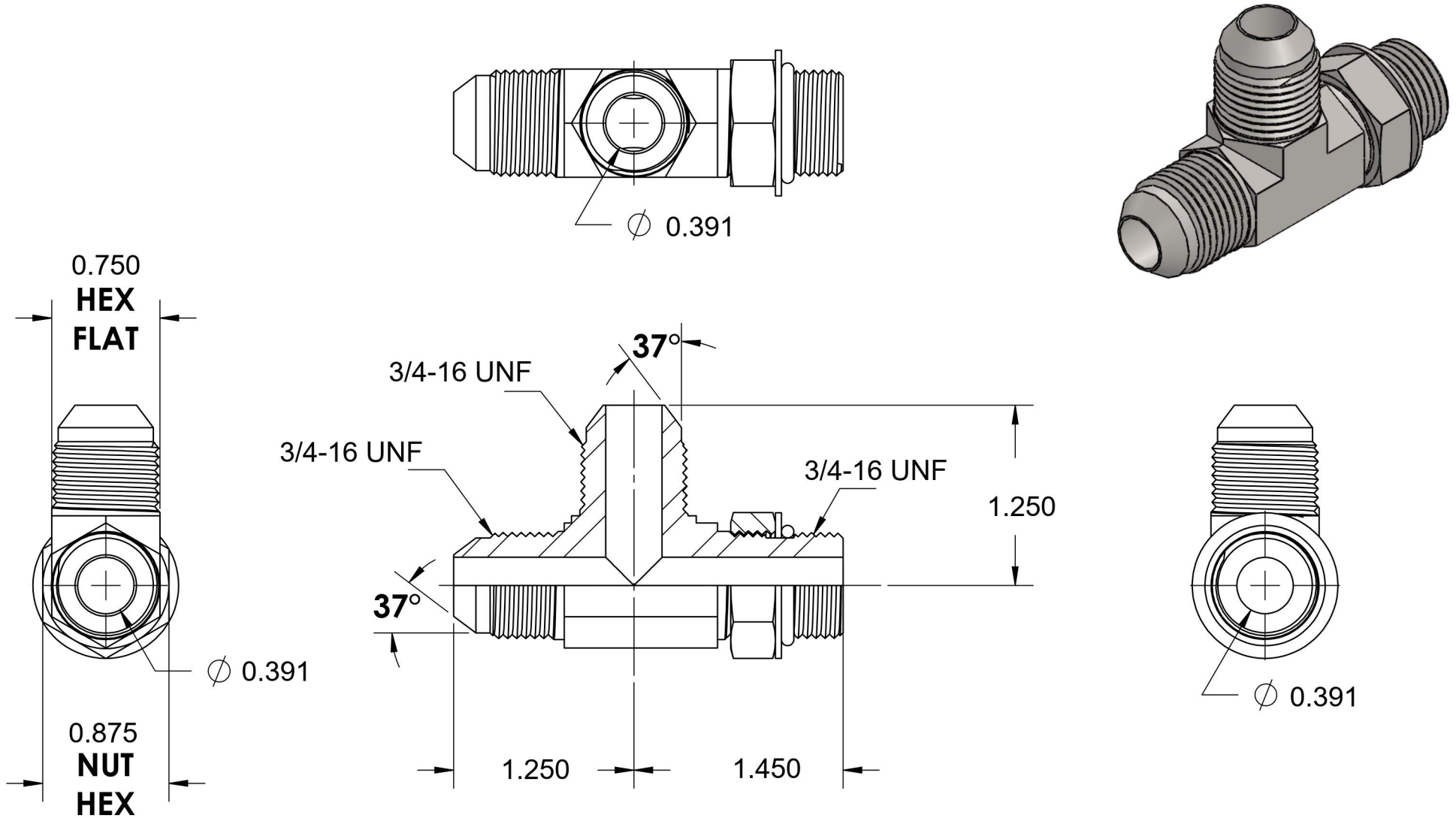

6701 Cochran Road
Solon, Ohio 44139
Phone: (440) 248-1880
Toll Free: 1-888-331-1523

Temperature Rating

-15°F to 400°F

Pressure Rating

6000 psi

Material

C1045 Steel

Finish

Trivalent Zinc

Industry Standards

SAE J514, SAE J1926-3
SAE J515, ASTM B633

Series

6804-NWO-FG-VITON

Series Description

SAE J514 37° Flare
Adjustable Port Run Tee