

6602-04-04-04-SS

Stainless Steel, SAE J514 37° Flare Swivel Run Tee, 1/4" Male JIC x 1/4" Female JIC Swivel x 1/4" Male JIC

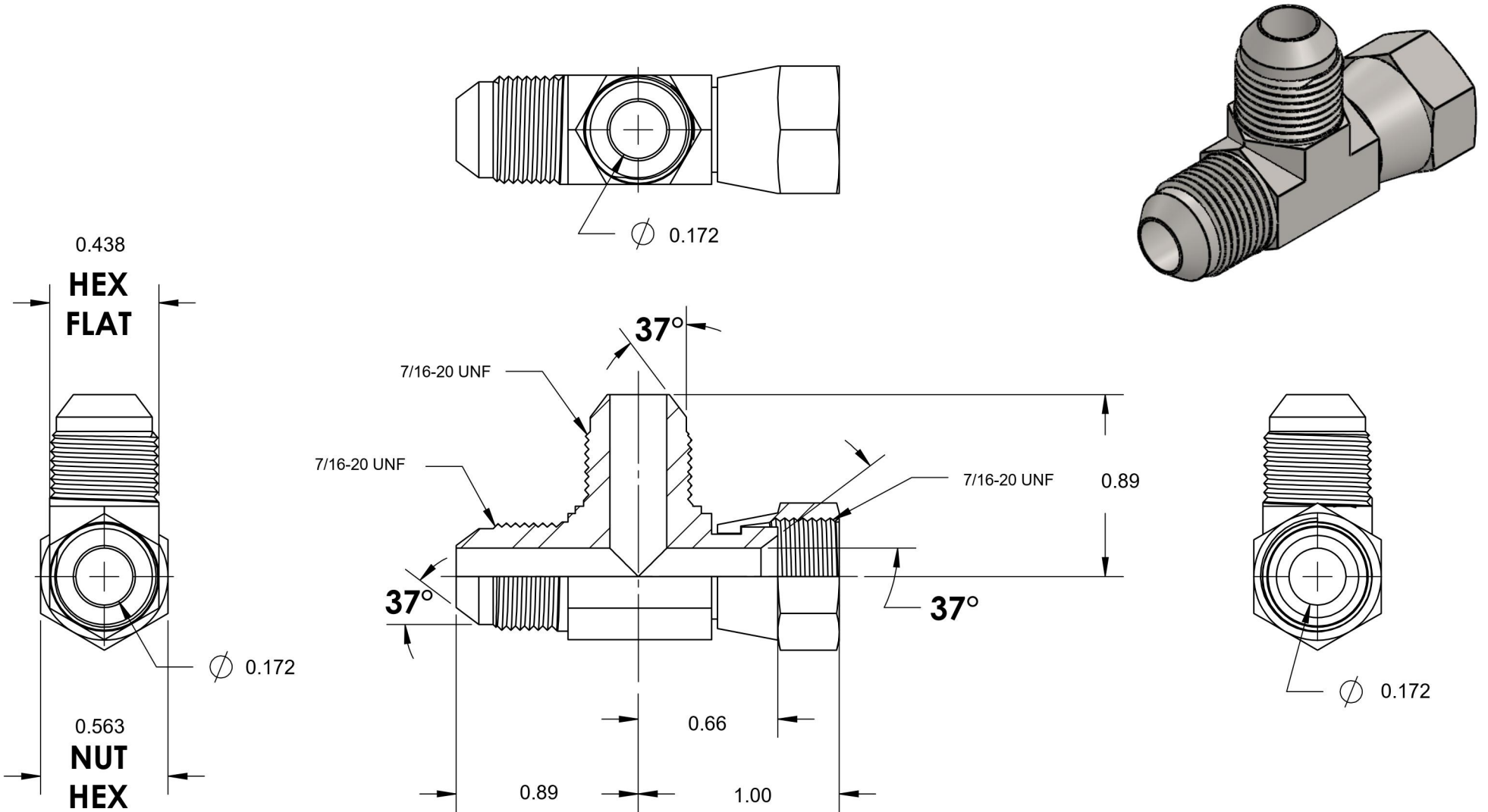

6701 Cochran Road
Solon, Ohio 44139
Phone: (440) 248-1880
Toll Free: 1-888-331-1523

Temperature Rating	Material	Industry Standards	Series
-425°F to 1200°F	316/316L Stainless Steel	SAE J514	6602-SS
Pressure Rating	Finish		Series Description
7700 psi	Passivated		SAE J514 37° Flare Swivel Run Tee