

6801-12-10-NWO-SS

Stainless Steel, SAE J514 37° Flare 90° Adjustable Port Elbow, 3/4" Male JIC x 7/8-14 Male Adjustable ORB

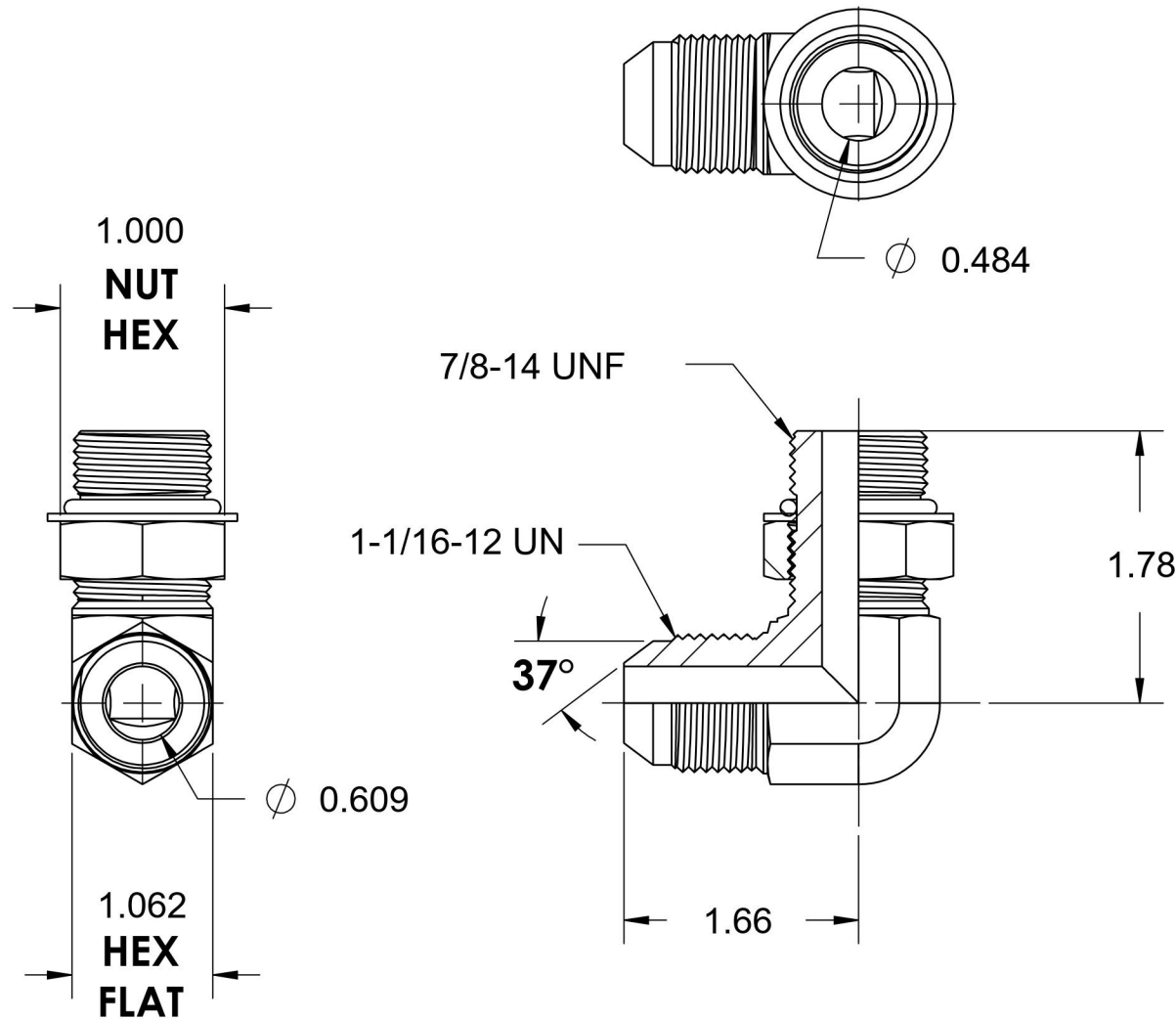

6701 Cochran Road
Solon, Ohio 44139
Phone: (440) 248-1880
Toll Free: 1-888-331-1523

| | | | |
|---------------------------|--------------------------|---------------------------|--|
| Temperature Rating | Material | Industry Standards | Series |
| -40°F / 250°F | 316/316L Stainless Steel | SAE J514, SAE J1926-3 | 6801-NWO-SS |
| Pressure Rating | Finish | | Series Description |
| 5400 psi | Passivated | | SAE J514 37° Flare 90° Adjustable Port Elbow |