

1724-20-SS

20 O-Ring Face Flange Plug Code 61 Stnls

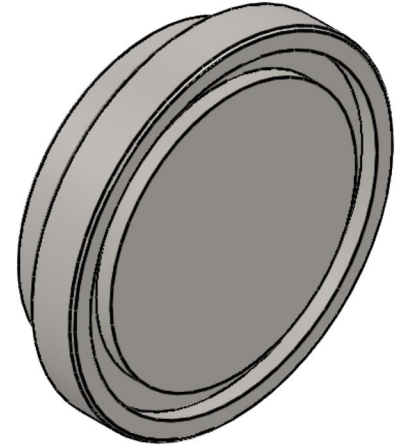
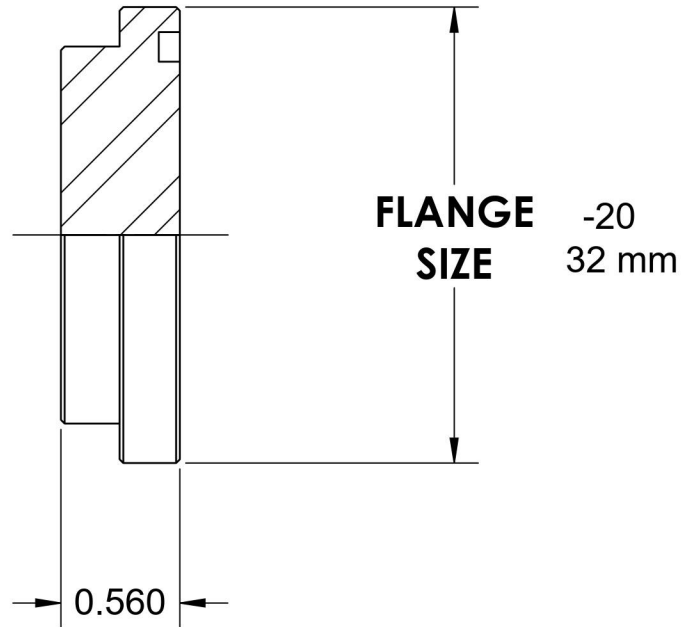
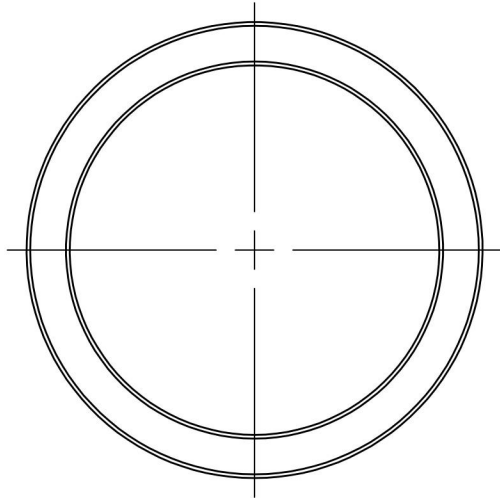

6701 Cochran Road
Solon, Ohio 44139
Phone: (440) 248-1880
Toll Free: 1-888-331-1523

Temperature Rating -425°F to 1200°F	Material 316/316L Stainless Steel	Industry Standards SAE J518 Code 61	Series 1724-SS
Pressure Rating 4000 psi	Finish Passivated		Series Description SAE J518 Code 61 Split Flange Plug