

D2408-L08-SS-X

Stainless Steel, DIN 2353 Plug, Light 8mm Tube OD, Body Only

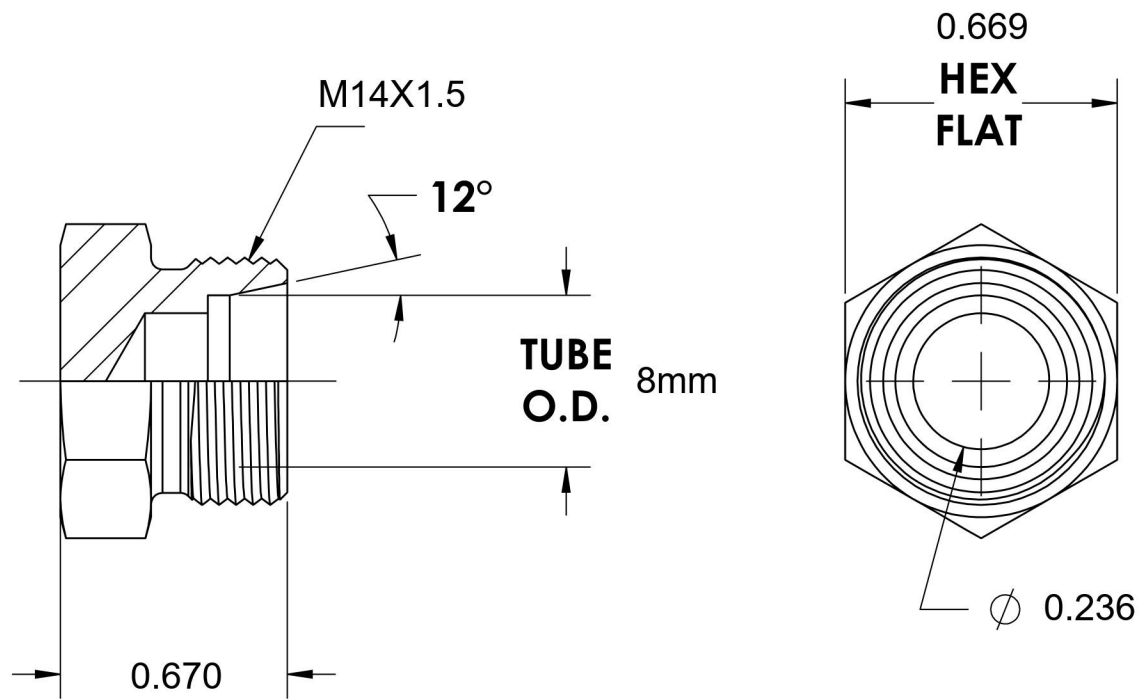
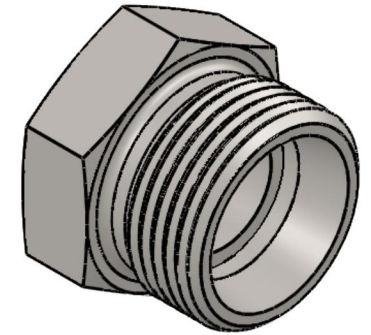

6701 Cochran Road
Solon, Ohio 44139
Phone: (440) 248-1880
Toll Free: 1-888-331-1523

Temperature Rating

-425°F to 1200°F

Pressure Rating

7252 psi

Material

316Ti Stainless Steel

Finish

Passivated

Industry Standards

DIN 2353, ISO 8434-1

Series

D2408-SS-X

Series Description

DIN 2353 Flareless
Tube Plug, Body Only