

C0319-14

Steel, SAE J514 Flareless Tube Ferrule, 7/8" Flareless Bite Type Sleeve Type A

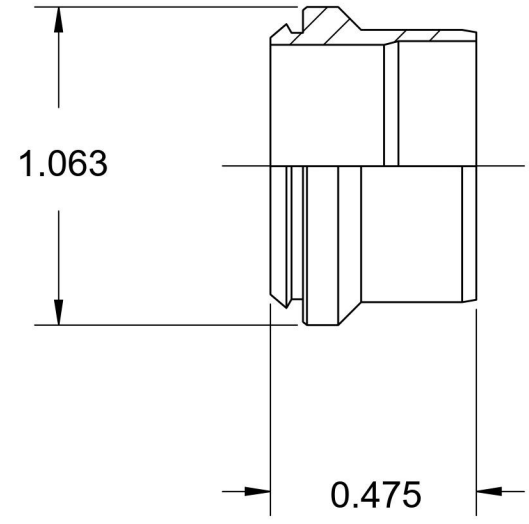
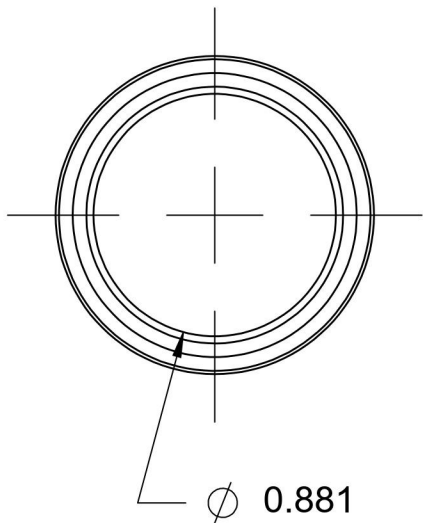

6701 Cochran Road
Solon, Ohio 44139
Phone: (440) 248-1880
Toll Free: 1-888-331-1523

Temperature Rating -65°F to 500°F	Material Low Carbon Steel	Industry Standards SAE J514, AMS 2769 MIL-DTL-16236, ASTM-F1137	Series C0319
Pressure Rating Not Available	Finish Zinc Phosphate Heat Treat per AMS 2769		Series Description SAE J514 Flareless Tube Ferrule