

6504-12-12

Steel, SAE J514 37° Flare Swivel Adapter, 3/4" Male JIC x 3/4" Female JIC Swivel

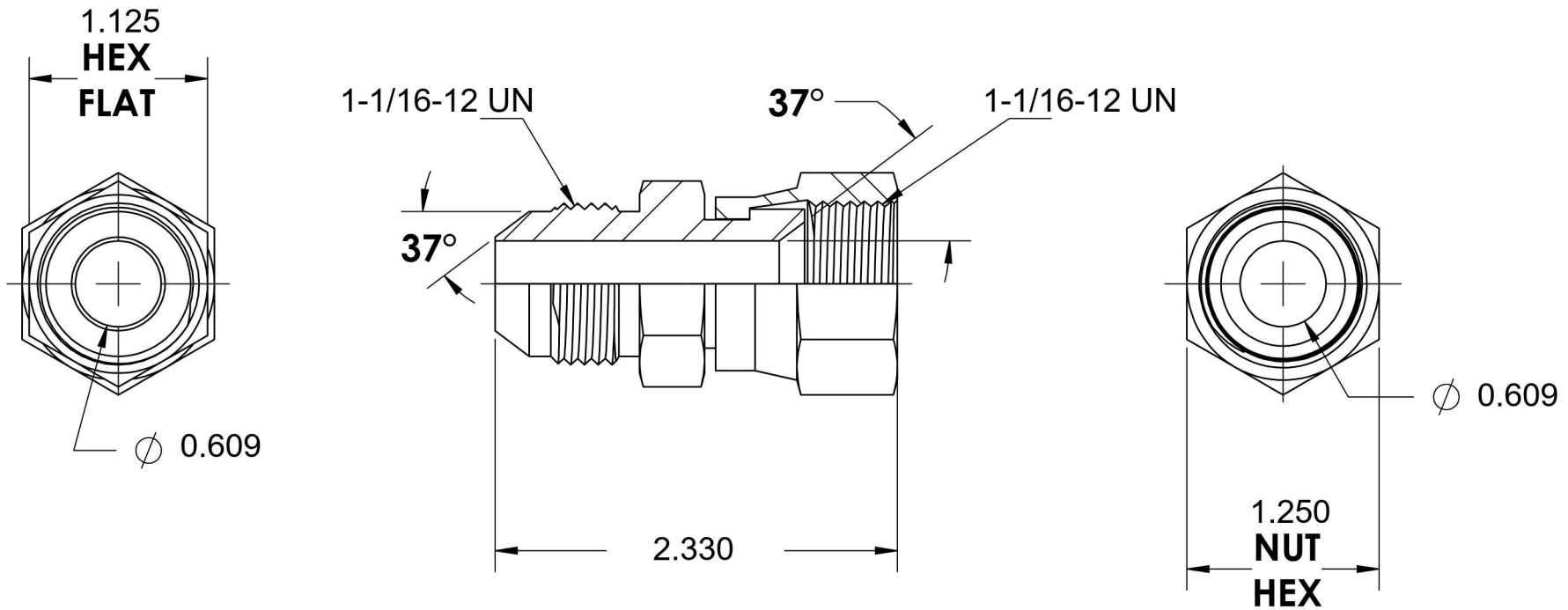
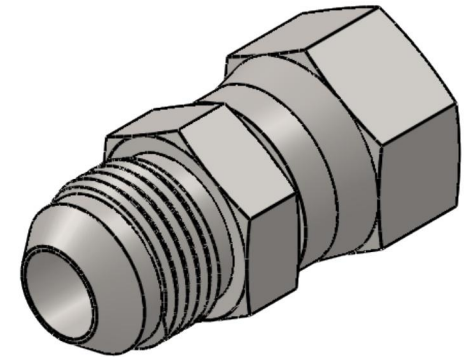

6701 Cochran Road
Solon, Ohio 44139
Phone: (440) 248-1880
Toll Free: 1-888-331-1523

Temperature Rating

-65°F to 500°F

Pressure Rating

5000 psi

Material

C1045/12L14 Steel

Finish

Trivalent Zinc

Industry Standards

SAE J514, ASTM B633

Series

6504

Series Description

SAE J514 37° Flare Swivel Adapter