

6902-32-32-NWO-SS

Stainless Steel, SAE J514 NPSM Swivel 45° Adjustable Port Elbow, 2-1/2-12 Male Adjustable ORB x 2" Female NPSM Swivel

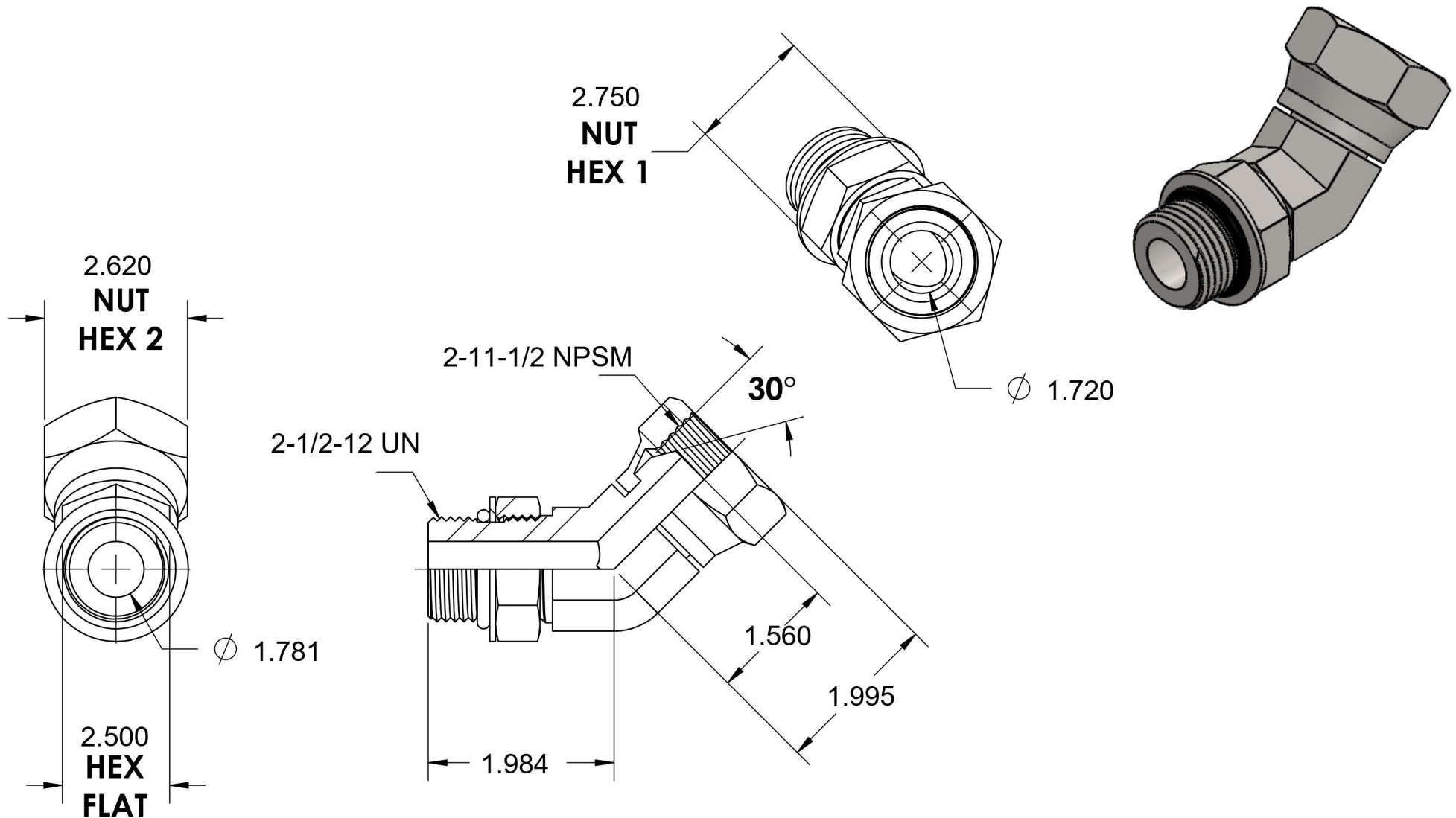

6701 Cochran Road
Solon, Ohio 44139
Phone: (440) 248-1880
Toll Free: 1-888-331-1523

Temperature Rating	Material	Industry Standards	Series
-40°F to 250°F	316/316L Stainless Steel	SAE J514, SAE J1926-3 SAE J515	6902-NWO-FG
Pressure Rating	Finish		Series Description
1100psi	Passivation		SAE J514 NPSM Swivel 45° Adjustable Port Elbow