

# C2501-06-02-FG

Steel, SAE J514 Flareless Tube 90° Male Elbow, 3/8" Flareless Bite Type x 1/8" Male NPTF 30°

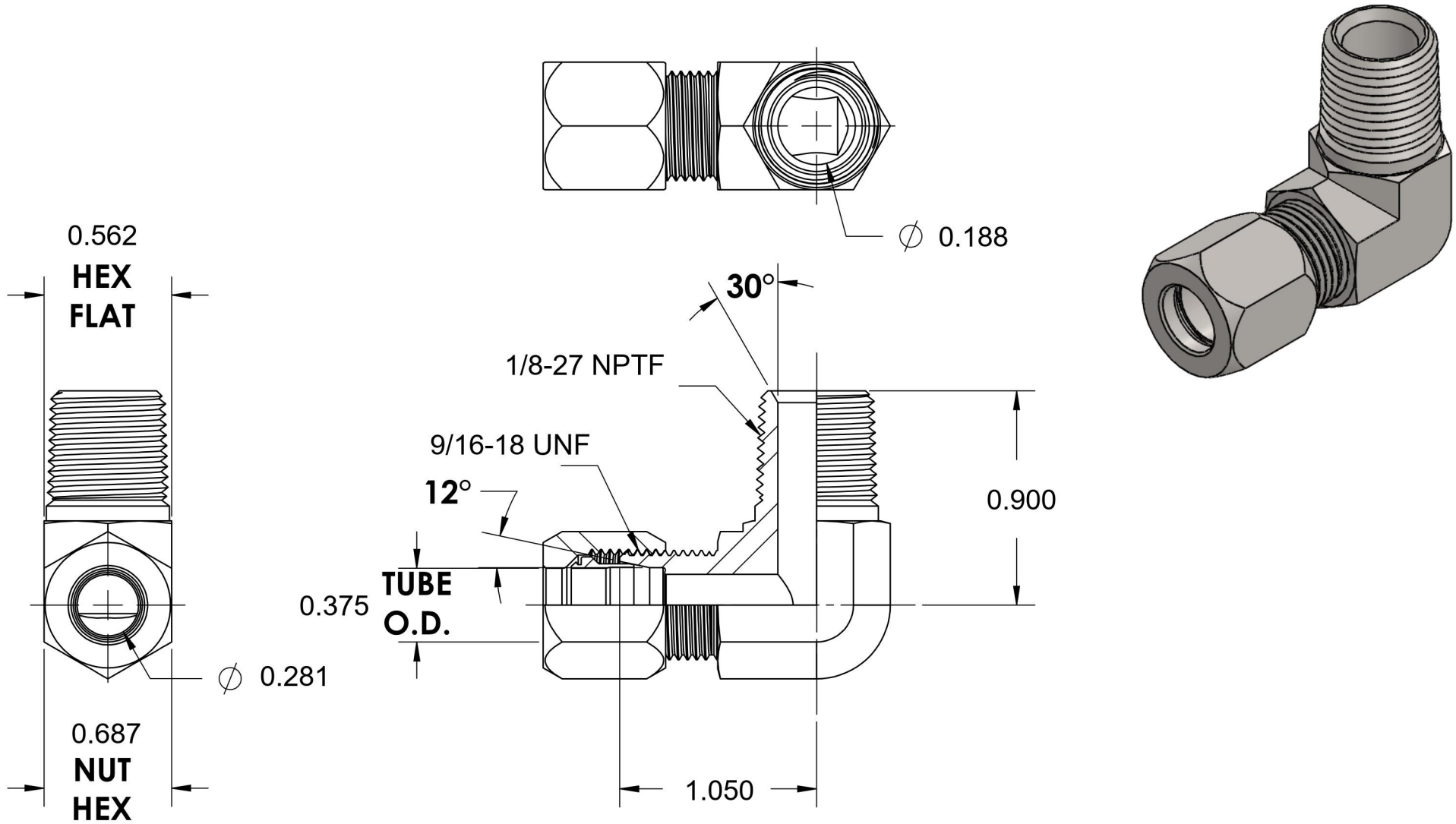

6701 Cochran Road  
Solon, Ohio 44139  
Phone: (440) 248-1880  
Toll Free: 1-888-331-1523

**Temperature Rating**

-65°F to 500°F

**Pressure Rating**

5000 psi

**Material**

C1045 Steel

**Finish**

Trivalent Zinc

**Industry Standards**

SAE J514, SAE J476  
ASTM B633

**Series**

C2501-FG

**Series Description**

SAE J514 Flareless Tube  
90° Male Elbow