

6901-10-08-NWO-SS

Stainless Steel, SAE J514 NPSM Swivel 90° Adjustable Port Elbow, 7/8-14 Male Adjustable ORB x 1/2" Female NPSM Swivel

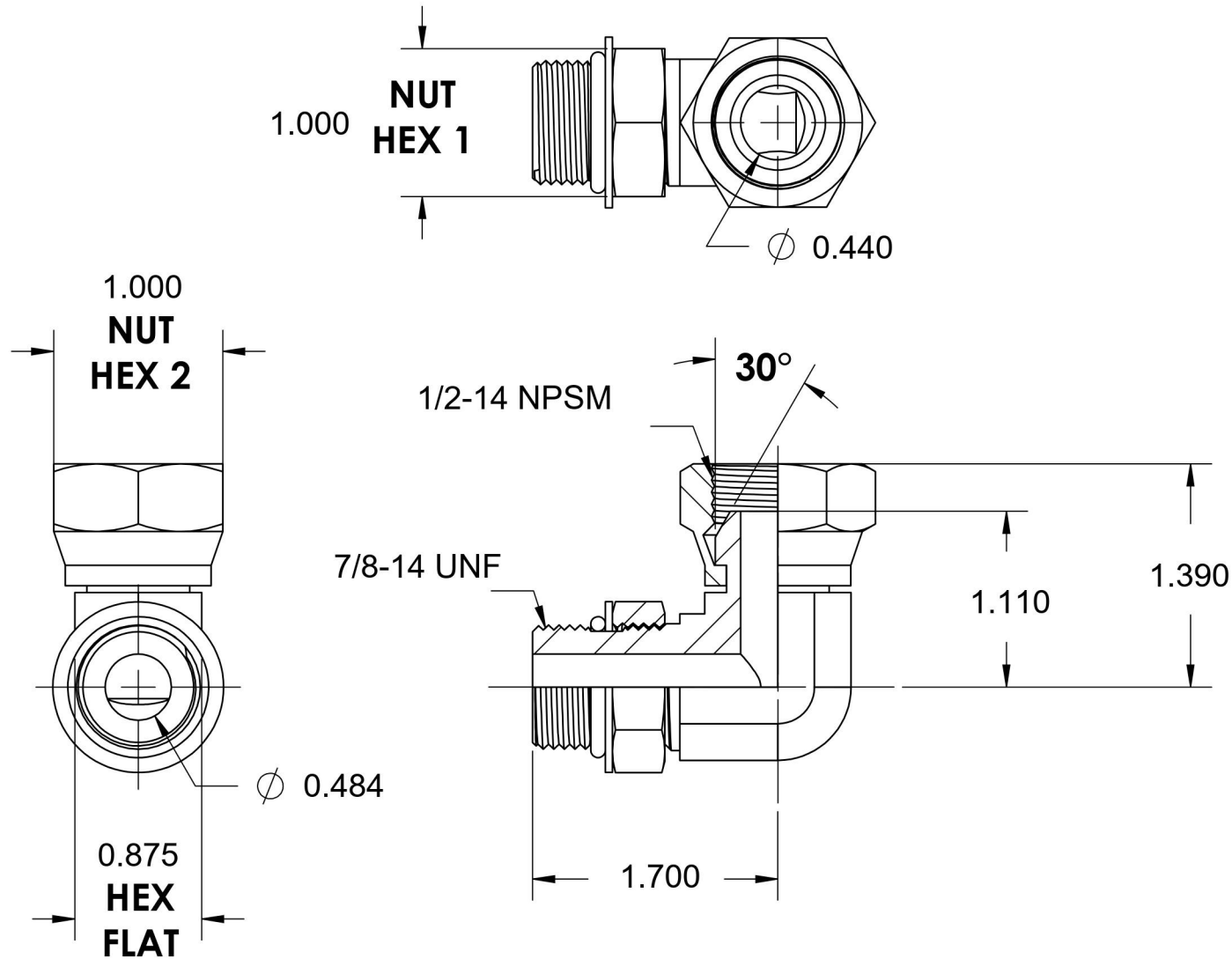

6701 Cochran Road
Solon, Ohio 44139
Phone: (440) 248-1880
Toll Free: 1-888-331-1523

Temperature Rating

-40°F to 250°F

Pressure Rating

5000 psi

Material

316/316L Stainless Steel

Finish

Passivated

Industry Standards

SAE J514, SAE J1926-3
SAE J515

Series

6901-NWO-SS

Series Description

SAE J514 NPSM Swivel 90° Adjustable Port Elbow